

ETHER NDE



Eddy Current Solutions

Eddy Current Instrument for Advanced Weld Inspection

WeldCheck+ **User Manual**



ETHer NDE Ltd.
Endeavour House,
Unit 18, Brick Knoll Park,
Ashley Road,
St Albans,
Hertfordshire,
AL1 5UG.

Tel: +44 (0) 1582 767912
www.ethernde.com
sales@ethernde.com

Contents

Contents	3
1 Introduction	6
1.1 About the WeldCheck+.....	6
1.2 A first look at the instrument.....	8
1.3 Keypad	10
1.3.1 <i>Cursor keys</i>	10
1.3.2 <i>Menu/Back Key</i>	11
1.4 Connector Side of the instrument (probe and charger connector):.....	14
1.5 Flap Side of the instrument (accessory connectors under flap).....	15
2 Standard Kit and recommended probe kits and accessories packages	16
2.1 Standard Kit.....	16
2.2 Recommended Probe Packages	17
2.3 Optional Accessories	20
3 Getting Started.....	21
3.1 Battery Charging.....	21
3.2 Switching the instrument on	21
3.3 The opening screen	22
3.4 Switching the Instrument Off	24

4	Operation	25
4.1	Operating screen	25
4.2	Main Menu	27
4.2.1	<i>Side Bar Programming Pane</i>	28
4.2.2	<i>Eddy Current Pane</i>	29
4.2.3	<i>Configure Pane</i>	36
4.2.4	<i>Display Pane</i>	40
4.2.5	<i>Advanced Pane</i>	42
5	Setting the WeldCheck+ to perform an inspection	54
5.1	With a configuration file	54
5.2	With no configuration files	54
5.3	Sample application setup	54
5.3.1	<i>Weld Probe Single Setting</i>	55
5.3.2	<i>Paint Probe (Weld Setting)</i>	57
5.3.3	<i>Weld Inspection with two probes</i>	58
5.3.4	<i>Weld Single Probe Dual Channel</i>	61
5.3.5	<i>High Frequency Surface Inspection</i>	63
5.3.6	<i>Low Frequency Sub-Surface Inspection</i>	68
5.3.7	<i>Dual Frequency Mixing</i>	70
5.3.8	<i>Conductivity</i>	75
6	Weld Probe Data	79

6.1	Standard Weld Probes - Bridge.....	79
6.2	Standard Weld Probe Coding System	82
6.3	Special Weld Probes - Bridge.....	85
6.4	High Temp Ceramic Tipped	86
6.5	More Specials	91
6.6	Broad Band/Paint Probes - Absolute	92
6.7	Test Blocks	93
7	Connectors	94
8	Software Update and System Recovery.....	96
8.1	Updating WeldCheck+ software.....	96
8.2	Default Mode.....	97
8.3	ETHerRealtime PC Package.....	97
8.3.1	<i>ETHerCheck Tabs</i>	<i>100</i>
9	Specification.....	104
10	System Self-Test Codes	108
11	Safety and Environmental.....	109
11.1	EC Declaration of Conformity	110

1 Introduction

1.1 About the WeldCheck+

The WeldCheck+ instrument is a dual frequency eddy current inspection instrument with conductivity. It is designed for flaw detection and evaluation using the Eddy Current non-destructive testing (NDT) inspection method particularly for use (but not exclusively) in Eddy Current Weld Inspection to “ISO 17643:2015 Eddy current examination of welds by complex plane analysis” (was BS EN 1711).

WeldCheck+ can perform a great many eddy current inspection tasks including weld inspection, surface defect detection, conductivity measurement and low frequency inspection of non-ferrous material. The dual channel/frequency capability means that the instrument can perform, in addition to single frequency, applications that require dual frequency. Examples of dual frequency are the suppression of unwanted signals by mixing or dual test with one probe (typically simultaneous absolute and differential testing) or dual probe testing where one probe must be absolute but the other could be any of the types the instrument can used with.

The WeldCheck+ is equally applicable to testing products either during manufacture or once in-service.

Due to its 10Hz-12.8MHz-frequency range it is able to detect surface and subsurface defects in components made from non-ferrous metals and their alloys and on ferrous materials can detect surface breaking defects.

Always refer to the applicable inspection and operator certification procedures and national and international standards before undertaking a test particularly those referring to certification of operators.

The instrument may be used with nearly all eddy current probes including:

- Absolute single element probes
- Absolute bridge connected probes
- Absolute reflection connected probes (e.g. Spot Absolute Probes)
- Differential bridge connected probes (e.g. ID Probes)
- Differential reflection connected probes
- Sliding transmit receive reflection probes

The User Manual of the ETHER NDE WeldCheck+ portable eddy current instrument (referred to as the "instrument") is intended to explain the operation principles of the instrument.



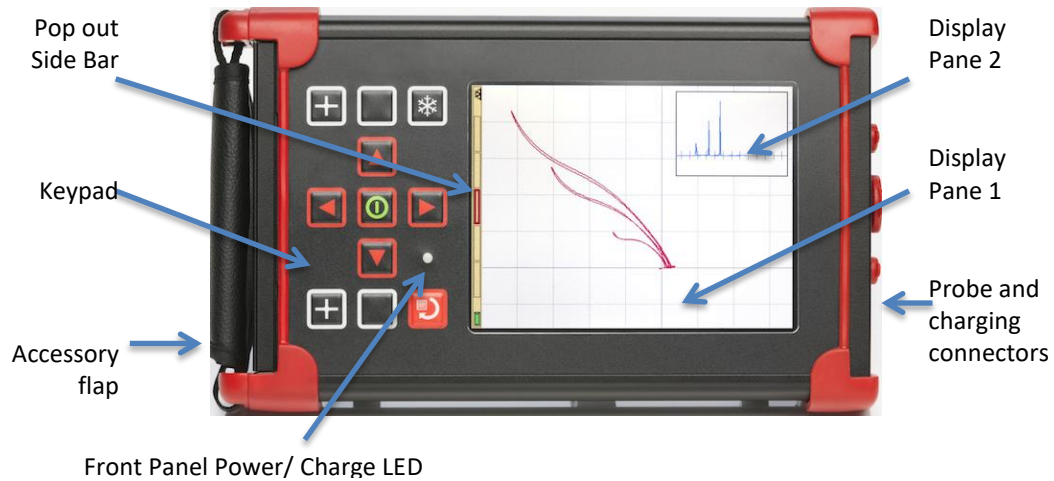

1.2 A first look at the instrument.

This section gives an overview of the various external features of the instrument.





Fig. 1– WeldCheck+ Front panel



Pressing the MENU/BACK key  toggles between the Main Menu and Operating screen.

4/1/17 15:09:40  dB 1    	Eddy current Probe Gain 1 Filters Lift Off Gain Summary	Configure Appearance Power save Time & Date Language Load & Save About.. Lock
	Display Graticule Spot Offset Persistence Panes	Advanced Alarm Alarm Zone Attachments Guides Record & Replay Auto Phase

Repeatedly pressing the LEFT & RIGHT cursor key changes the side bar on the left of the operating screen changes between Small, Normal and Quick-Menu CH1, and if dual frequency is selected then CH2 and Mix modes.

 15:58:21    dB 1 	Ch 1 Probe 30.00 kHz 59.5 Bridge Filters H DC L 300 Hz Gain X 54.0dB Y 54.0dB ⚡ Y=X ± 1.0dB	Ch 2 Probe 40.00 kHz 35.6 Bridge Filters H DC L 350 Hz Gain X 57.0dB Y 46.0dB ⚡ Y=X ± 1.0dB	Mix Phase 758.0 Gain X 6.0dB Y 6.0dB ⚡ Y=X ± 6.0dB	

1.3 Keypad

1.3.1 Cursor keys



Long press (greater than 3 seconds) on the centre/enter key switches the instrument on.

The 4 red arrow keys are cursor keys and the centre key acts as both the on/off key and the enter key.

In the operating screen pressing the right cursor key changes the side bar from the default setting of the user programmable quick access icons to the quick setting menu for channel 1, 2 or mix. Press the left cursor key to exit the quick-menu display.

In the operating screen pressing the left cursor key changes the side bar from the default setting to a smaller version, this allows a full screen view of the Main Pane. Press the right cursor key to expand the menu once again.

In the menu screens the direction keys move the cursor/selection point Left, Right, Up, Down. The centre key is used first to select a menu item. Once a menu item is selected its various values can be highlighted using the UP and DOWN keys. Pressing OK will then allow the individual highlighted value to be modified. Pressing Enter again will accept the value and return to having the sub menu highlighted. Press the Back Key to accept all values and return to the Main Menu.

Long press (greater than 3 seconds) on the centre/entre key switches the instrument off if a setting has been changed the operator will be prompted to save the current setting or not.

1.3.2 Menu/Back Key



The menu/back key gives quick access to the main Menu as well as going back to the previous item.



Eddy current signal balance (1 top one bottom of unit). Long Press (greater than 3 seconds) activates Auto Phase (see 5.2.5.6). In dual probe/channel mode the balance is split Ch1 Top and Ch2 Bottom Key if the Quick Menus are selected.



2 Independent User programmable blank soft keys, one top one bottom. A 3 second push on either of these will show a list of the programmable options. Up Down to select and centre key to Enter. Once programmed use a short press to activate key function. Functions selectable from;

- None
- Clear Screen – clear whole screen
- Clear Pane 1 – clear only pane 1

- Clear Pane 2 – clear only pane 2
- Screen Shot – Save bitmap of the current screen display. Note that Screen Shots are saved to the SD card and appear in a folder along with the currently selected settings.
- Auto Phase – Activates the Auto Phase setting function see 5.2.5.6.
- Balance Load – in absolute mode automatically optimises the balance load using one of the internal loads. See 5.2.2.1
- Screen Flip – toggles the screen orientation from right handed to left handed.
- Loop – records a short section (equal to persistence time) of data and displays it repetitively. This allows easy setting of gain, phase, filters, display and other parameters. Toggles on and off on key presses.
- Trace – Stores the current displayed trace in Pane 1 to the Graticule layer of the image. 2nd press erases this trace from the graticule layer. Good for making comparative tests. Toggles on and off on key presses.

Each key may be programmed separately allowing two different functions to be programmed. Programmed key settings are saved in a setting file so each setting can have the most useful function programmed.



Press to Freeze Display second press toggles/Long press to erase.



LED indicator Green indicates external power applied, amber indicates power applied and charging in progress. Green indicates charging complete and instrument on external power.

1.4 Connector Side of the instrument (probe and charger connector):



Probe Connectors – There are two different probe connectors;

a) Lemo 00 (Coaxial connector) to connect absolute probes. This connector is selected in the Menu Eddy Current /Probe Function as Absolute-00. To use our standard microdot absolute probes then use part number ALLCX-M02-015A and for BNC absolute probes use part number ALLCX-B02-015A. To connect Absolute probes with a cable terminated with a BNC connector at the instrument end then use adapter part number AALCX-B02S.

b) Probe Connector (12 way Lemo 2) connects Bridge, Reflection and Absolute probes. For Bridge probes using a 4 pin Lemo connector (e.g. disconnect weld probes) use part number ALL12-L04-015B. For Reflection probes (e.g. spot faced probes such as PUS13) use ALL12-L04-015R. By using adapter part number AAL12P-B02S then absolute probe with cables terminated with a BNC connector may be connected.

c) Power - only use the factory supplied charger/power supply

1.5 Flap Side of the instrument (accessory connectors under flap)

Open the flap by gripping the flap firmly, whilst pushing from the back and then rotate the flap open as shown below.



NOTE: Do not use tools to open, as this will damage the instrument.

VGA - for video output using a

monitor, projector or head up display

Micro SDHC Card - can add up to 32GB of removable memory

USB - used to connect to a PC for data transfer and remote operation

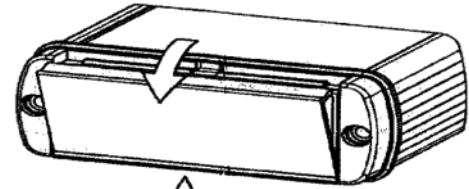

To Open Flap

- 1 Press centrally on hinge axis
- 2 Simultaneously pry open cap

2 Standard Kit and recommended probe kits and accessories packages

2.1 Standard Kit

Description	Part. No.	Qty.
KIT, WeldCheck+, Eddy Current Portable Flaw Detector. Including:	KIWEL002	1
WeldCheck+ Instrument including USB Stick with manual	KIWEL002	1
Accessory, WeldCheck+, Power Adapter + Input Plugs (UK, EU, US & Australia)	AWEL002	1
Accessory, Adjustable Padded Shoulder Strap Quick-Release Clips	AWEL003	1
Accessory, Instrument Soft Carry Case , (WeldCheck/Vantage)	AC006	1
Accessory, Lead, Lemo 00 to Microdot, 1.5m	ALLCX-B02-015A	1
Accessory, Lead, Lemo 12-Way - Lemo 4-Way, , 1.5m (Bridge)	ALL12-L04-015B	1
USB CABLE - A to MINI B, 1m	A090	1
Quick Reference Card	40463	1

2.2 Recommended Probe Packages

KIT, Weld, Probes + Accessories. Including:

KAWEL001

Probe, Weld, Dia 16.00mm (Medium) 100kHz, , Straight, Disconnect	PWM100S000	1
Probe, Unshielded, Broad Band, 100k , (35kHz-250kHz), BNC	PUB100K	1
Accessory. Test Block, Weld Probe, Ferrous , (Steel EN1A) + x4 0.5mm Shims, , 0.5, 1.0, 2.0mm slots	ATBW	1
Accessory, Lead, Lemo 12-Way - Lemo 4-Way, 1.5m (Bridge)	ALL12-L04-015B	1
Accessory, Lead, Lemo 00 to BNC, 1.5m	ALLCX-B02-015A	1
Accessory, Butterfly PTFE Tape (Pack of 30)	AW003	1
Accessory, Deluxe Probe Case PHDC1	AC002	1

KIT, Surface Inspection. Including:

KASUR001

Probe, Unshielded, 500kHz, Fe/NFe, Plastic Handle, Straight, 100mm Long	PU500PSFE/NFE	1
Probe, Shielded, 2MHz, Plastic Handle, Straight, 28mm Tip Length (Total Length 114mm, 4.5") (Straight Shank)	PS002PS028-114N	1
Probe, Shielded, 2MHz, Plastic Handle, Straight, 28mm Tip Length (Total Length 114mm, 4.5") (Straight Shank)	PS500PD064-114N	1

Probe, Shielded, 2MHz, Plastic Handle, Double Crank, 6.4 (0.25") Tip Length (Total Length 114mm, 4.5") (15deg Crank, 90deg tip Shank)	PS002PD064-114N	1
Probe, Knife, 65 deg, 2MHz, NFe, Unshielded	PK065002NFE	1
Cable Lemo 00 Coaxial to Microdot Plug Absolute cable 1.5m	ALLCX-M02-015A	1
Test Block, Ferrous (Steel EN1A), 0.2, 0.5, 1.0mm slots	ATBF	1
Accessory. Test Block, Ferrous (Steel EN1A), 0.2, 0.5, 1.0mm slots	ATBA	1
Accessory, Butterfly PTFE Tape (Pack of 30)	AW003	1
Accessory, Deluxe Probe Case	AC002	1

Kit, Sub-surface Inspection Low Frequency. Including: KASUBS001 1

Probe, Surface, Straight, Dia 16mm, 300Hz - 100KHz, Plastic, Lemo 4-Way	PUS16	1
Probe, Surface, Right Angled, Dia 11mm, 300Hz - 100KHz, Plastic, Lemo 4-Way	PUR11	1
Accessory, Lead, Lemo 12-Way - Lemo 4-Way, 1.5m (Reflection)	ALL12-L04-015R	1
Accessory, Test Block, Aluminium 7075-T6, 1.6mm Thick, x4 Flat Bottom Holes 75%(1.2mm), 50%(0.8mm), 25%(0.4mm), 12.5%(0.2mm) Deep.	ATB001	1

KATUB001

KIT, Tube Inspection Probes including the following accessories;

Probe, Internal Diameter, Differential, Dia 13.80mm, Disconnect, 18kHz.	PID138D0018K	1
Accessory, ID Lead, 12-Way Lemo, Flexible, 3.0m	CIDL03F	1
Accessory, Test Block, Tube, Brass, OD 5/8", (15.87mm) x 20swg, Calibration Tube	ATBTB1587	1
Accessory, Test Block, ID Probe Support Ring, OD 25.4 x ID 16.6 x 20.00mm Long	ATB010	1

2.3 *Optional Accessories*

Description	Part. No.	Qty.
Accessory, Protective Splash Proof Cover	AAER004	1
Accessory, Lead, Lemo 00 to Microdot, 1.5m	ALLCX-M02-015A	1
Accessory, Lead, Lemo 12-Way - BNC Plug, 1.5m (Absolute)	ALL12-B02-015A	1
Accessory, Lead, Lemo 12-Way - Lemo 4-Way, 1.5m (Bridge)	ALL12-L04-015B	1
Accessory, Lead, Lemo 12-Way - Lemo 4-Way, 1.5m(Reflection)	ALL12-L04-015R	1
Accessory, Lead, Lemo 12-Way to x2 Micro Plug, 1.5m (RX TX) (Reflection)	ALL12-M02-M02-015AR	1
Accessory, PELIE STORM iM2300 Case with custom foam inserts	AAER002	1
Accessory, Adapter Lemo 00 Coaxial to BNC Socket	AALCX-B02S	1
External 8*AA Dry Cell External Battery Pack	AWEL006	1
Wrist Strap	AWEL007	1
In car power adapter/charger	AWEL008	1
Tripod Bracket - To fit 1/4" Camera Tripod Mount with Male Screw	40470	1
Accessory, In Car 12V Power Adapter (12V, 5.5 x 2.5mm Plug)	AWEL008	1

3 Getting Started

3.1 Battery Charging

1. Connect the instrument's AC/DC supply to the DC power socket. When DC power is connected, the green or amber DC LED will stay on. NOTE: DO NOT CONNECT AN AC/DC POWER PACK other than one's supplied by ETHER NDE otherwise the warranty will be void and irreparable damage will occur to the instrument. Options are AWEL002 (AC Charger), AWEL006 (Dry Cell Pack) and In-car charger (AWEL008).
2. As soon as the DC power is connected, the battery will start to be charged. With the instrument powered down the battery will charge fully within 2 hours.
3. During charging the front panel LED is Amber, when charging is complete the LED colour changes to Green. If the instrument is powered up and used during charging the battery will charge more slowly than if the unit was not powered up.
4. Note the instrument may be used whilst charging is taking place.

3.2 Switching the instrument on

1. Press the POWER key until the display turns on (should be within 3 seconds).
2. The instrument will first display the product splash screen for 3 seconds

3.3 The opening screen

The first screen the user will see once the equipment is powered up is the splash screen. Following the splash screen one of two screens will be displayed.

1) If favourites have been set then a Welcome Screen is displayed.

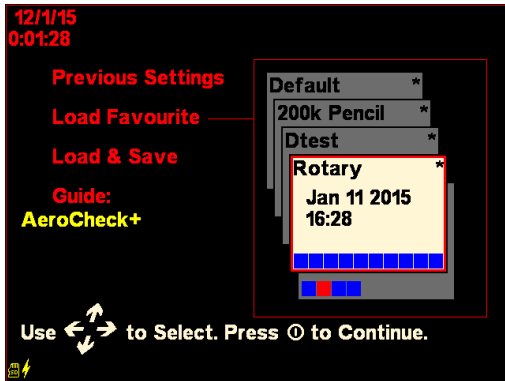

Previous Settings – instrument will return to the settings used last time the equipment powered down

Load Favourite – select from one of the favourites on the right of the screen

Load & Save – short cut directly to the Load & Save Menu

Guide – the instrument can display guides. This item will only appear if a favourite selected in the right pane has a guide associated with it e.g. along with the Default Favourite there is an associated Guide called WeldCheck+, which is a quick guide to operating the instrument. On the left there are three functions.

2) Otherwise the operating screen is shown. On the left on the side bar are 4 icons that are user programmable soft keys, plus the lower icon is the last function used by the user from the Main Menu or the alarm if the alarm is set active.

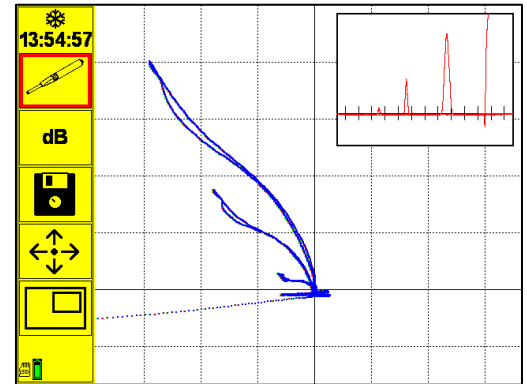

- 3) In the Operating screen pressing the right cursor key reveals the Quick Menu on the side bar. The Quick Menu provides a convenient, quick and simple way to make adjustments during a test. Use up down cursor keys to change the item selected and then press enter to adjust and up/down cursor keys now adjusts the parameter and enter.
- 4) One left press then returns to the Icon Side Bar.
- 5) A further Left cursor press shrinks the side bar as shown to the right. In this mode, all menu items are still usable. A further Right cursor press reveals the Icon Side Bar Again.

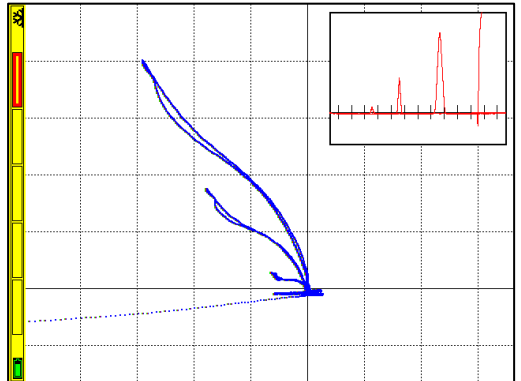
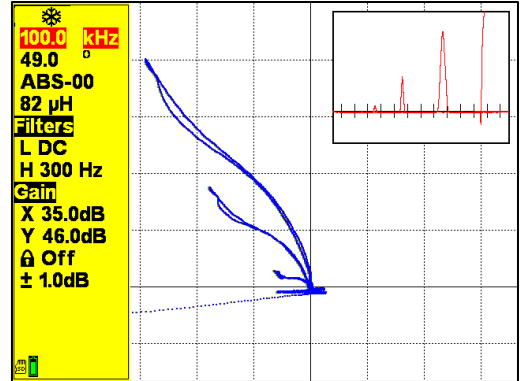

- 6) Pressing then Menu/Back Key reveals the main menu. Pressing the Menu/Back Key then returns to the Real Time display.

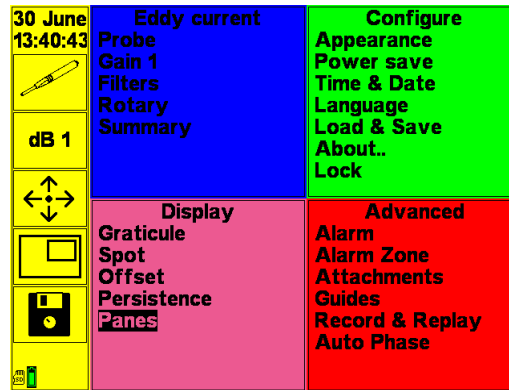

3.4 Switching the Instrument Off

Press the On/Off Enter key in the centre of the cursor keys for 3 seconds and release.

4 Operation

Once the Instrument has powered up then the Operating screen is displayed if no favourites are selected (otherwise see 3.3).

4.1 Operating screen

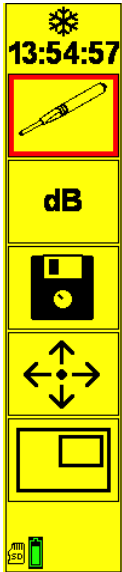

The Operating screen has to the left a Side Bar.

There is a Snowflake icon at the top of the Side Bar to indicate if the display is frozen (note a frozen display will not show live data). Usually the Date will be visible here. To unfreeze a short press on the freeze button and a long press clears the screen. The time is shown below.

The top four icons are user programmable. See 5.2.1 for how to programme these icons.

The Fifth Icon slot is automatically the last item used on the Menu if it is not already programmed as an Icon unless the alarm is in use.

SD card present Icon, Battery Level (or a lightning icon indicates that external power is present) and a Spinning Replay Icon shows that a replayed signal is being displayed.

Select an Icon and then press the Enter Key to display to display a summary menu at the bottom of the screen. Use the right left key to highlight an item and Cursor Up/Down to increase and decrease the item. Press the Menu/Back Key to exit the summary menu.

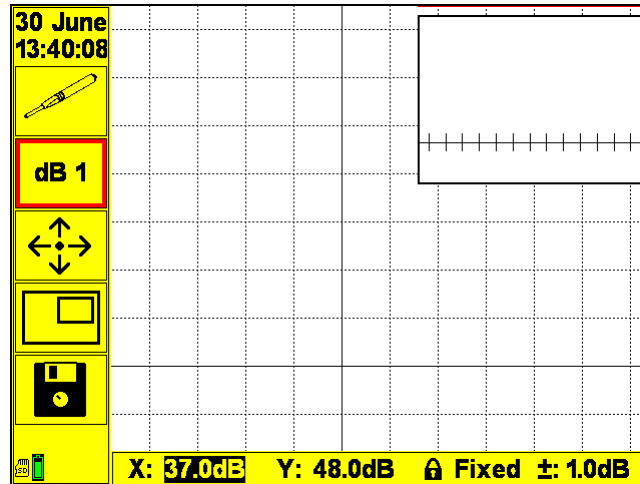

4.2 Main Menu

Press the Menu/Back Key to reveal the Main Menu. Depending on operation mode the screen may look different;

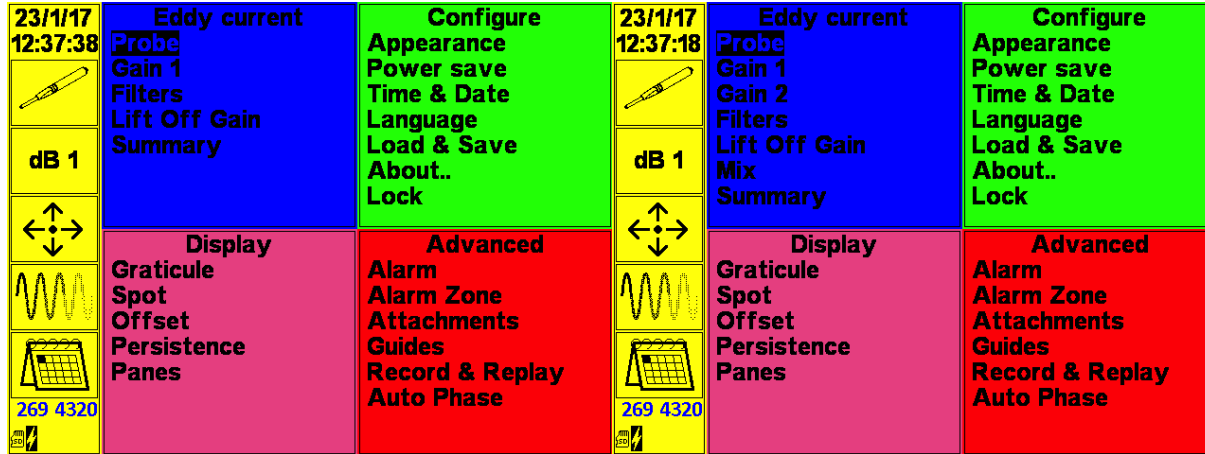

Single Channel

Dual Channel

The Menu is divided into several panes for ease of use. The Right/Left Cursor Keys select the pane and the up/down cursor key select individual items. Then press the Enter Key to select and the Menu/Back to leave the

item. Then press the Enter Key to adjust the parameter and the Enter to leave the parameter. Pressing the Menu/Back key again to return the user to the Operating screen.

4.2.1 Side Bar Programming Pane

Programming of the Side Bar icons is done in the Menu Screen. To remove one of the top 4 icons, select the unneeded icon and perform a long press (3 seconds) on the Back/Menu Key.

To add a Menu Item, there needs to be an empty icon slot, select the item on the Menu and then perform a long press (3 seconds) on the Back/Menu Key.

The 5th slot is always the last Menu Item that was viewed, assuming that this is not already one of the top 4 or the alarm is activated.

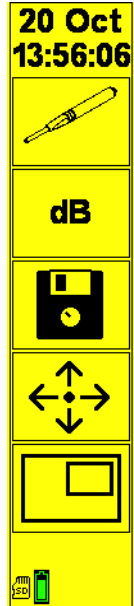

4.2.2 Eddy Current Pane

Parameters that can be adjusted are;

4.2.2.1 Probe

- Mode = Single or Dual
- Freq 1: Channel 1 frequency adjustable from 20Hz-20MHz.
- Phase 1: Channel 1 phase adjustable from 0.0-359.9 degrees with 0.1 degree precision
- Freq 2: Channel 2 frequency adjustable from 20Hz-20MHz. *
- Phase 2: Channel 2 phase adjustable from 0.0-359.9 degrees with 0.1 degree precision*
* = only visible if Mode set to dual.
- Type: Sets how the probe is connected. Selectable from
 - a. Absolute-12= Absolute single element probe using 12 way Lemo Connector
 - b. Absolute-00 = Absolute single element probe using Lemo 00 coaxial Connector
 - c. Bridge = Bridge probes using 12 way Lemo Connector
 - d. Reflection = Reflection (Transmit-Receive or Transformer) probes using 12 way Lemo Connector
 - e. Abs1/Diff2 = Dual Probe mode with Lemo 00 for Absolute on Channel 1 and Differential/Bridge on the Lemo 12 way on Channel 2
 - f. Abs1/Ref12 = Dual Probe mode with Lemo 00 for Absolute on Channel 1 and Reflection on the Lemo 12 way on Channel 2
 - g. Abs&Diff IntL = simultaneous Dual Differential and Absolute mode on the same probe using an internal balance load.

- h. Abs&Diff ExtL = simultaneous Dual Differential and Absolute mode on the same probe using an external balance load connected to the Lemo 00 connector. Must match the probe type and cable used.
- Load: Used to match single element absolute probes. Settable from Auto and from 2.2uH-82uH in 15 increments.

To use the Auto Load selection feature; Select the Probe Menu Item Load and then change the value to Auto. Then set one of the Soft keys (long press) to Balance Load. With the probe required connected and preferably in contact with the test surface then Press the assigned key momentarily to perform Auto Balance Load selection.

4.2.2.2 Gain 1

Channel 1 gain parameters;

- Gain X: Horizontal gain in dB -18 to + 82 dB Range Settable to 0.1dB resolution.
- Gain Y: Vertical gain in dB -18 to + 82 dB Range Settable to 0.1dB resolution.
- Gain Lock: which may be set off (X and Y Gain are individually adjustable), Y=X; both gain values are equal and Fixed: where the dB ratio between the X/Y values is kept a constant difference (and hence the X/Y signal ratio remains constant).
- Increment: Sets the gain adjustment precision to either 0.1, 1 or 6dB
- Drive: Set the drive level at 0, 6 or 10dB
- Input Gain: sets the input Gain 0 or 12 dB

4.2.2.3 Gain 2

Channel 2 gain parameters;

- Gain X: Horizontal gain in dB -18 to + 82 dB Range Settable to 0.1dB resolution.
- Gain Y: Vertical gain in dB -18 to + 82 dB Range Settable to 0.1dB resolution.
- Gain Lock: which may be set of (X and Y Gain are individually adjustable), Y=X; both gain values are equal and Fixed: where the dB ratio between the X/Y values is kept a constant difference (and hence the X/Y signal ratio remains constant).
- Increment: Sets the adjustment precision to either 0.1, 1 or 6dB
- Drive: Set the drive level at 0, 6 or 10dB
- Input Gain: sets the input Gain 0 or 12 dB

4.2.2.4 Filters

- High Pass: Settable from DC= Off, 6 slow balance drift compensation filters from 0.01 Hz to 0.5 Hz and then conventional filters from 1 -2000Hz. Used to reduce unwanted low frequency signals.
- Low Pass Filter: Settable from 5-2000Hz. Used to reduce unwanted high frequency noise. Default value for manual inspection is 300Hz.
- Filter Lock: Off = both filters may be adjusted separately and Ratio: where the filters stay a fixed ratio apart.
- Increment: Sets the precision of the adjustment adjustable from 0.10 to 100.

4.2.2.5 Lift Off Gain

The Lift Off Gain (LOGC) is a feature that automatically compensates the gain of the defect channel according to the paint thickness this ensuring that a defect signal will appear the same height irrespective of the paint thickness.

In order to achieve this, a calibration routine must be performed.

The only value required before the calibration is the users preference of how high they would like the 1mm defect to be above the origin, known as the **Max Height %**. **The Max height %** is adjustable in the **Lift Off Gain** menu within the **Eddy Current** menu items.

The LOGC Calibration routine is started using a press of a correctly configured BLANK Key press. Once began, follow the on-screen instructions. Here is a detailed walk-through of the process:

- 1. Performing Auto Load.** Hold the probe in the air while the instrument identifies the best internal load to use with the probe.
- 2. Place Probe on ATBW, away from defects, Press BALANCE.** Hold the probe with the finger indents pointing to the ends of the steel test block. Place the probe in-between the 1mm and 2mm slots. Press the BALANCE button to centre both signals. KEEP THE PROBE ON THE TEST BLOCK.
- 3. Lift the Probe.** Lift the Probe vertically. Once the RED trace exits the circle, the angle of the Lift-Off signal is set to be Vertical.
- 4. Move Probe over 1mm defect.** Put the probe back on to the steel test block in the same place as before, between the 1mm and 2mm defects, ensuring the finger indents are perfectly aligned with the ends of the

test block. Move the Probe over the 1mm defect. Once the BLUE trace exits the circle, the angle of the Defect signal is set to be Vertical.

Now the screen changes to show two panes. The Left indicates the amount of Lift-Off (or Paint thickness) and the Right shows the any Defects. For each of the following steps, the Lift Off (Left pane) spot must be BELOW the dotted trigger line when on the test piece and above it when in the air. The Defect spot (Right pane) must be below its trigger line when on a good part of the test block but then rise above its trigger line when passing over a defect. Each pane has an LED image below it. If the Left LED is RED when the probe is on the test block (and the requested shims) then the trigger line must be lowered by using the arrow keys. If the Right LED is RED when on the test piece then this trigger line must be lowered. To move a trigger line up or down, press the UP or DOWN arrow key. The Panes trigger line being repositioned will have an arrow next to its respective LED. Use the LEFT or RIGHT arrow keys to select either the LEFT or RIGHT panes. Once editing has begun, the LEDs will go WHITE. Between each of the following steps the LEDs will also go WHITE. WHITE LEDs indicate that the probe must be lifted in to AIR to indicate that the user is ready to continue.

If both LEDs are GREEN but moving the probe over the defect fails to be recognised, check that the defect spot rises from below to above its trigger line, If it doesn't, adjust the position of this line.

5. **Move Probe over 1mm defect.** If the LEDs are WHITE, lift the probe off the material. Return the Probe to the position on the test block between the 1mm and 2mm defect slots. Move the probe over the 1mm defect. If the instrument fails to move to the next Step, see the text above for adjusting trigger lines.
6. **Repeat using 0.5mm Shim.** Remove the probe from the test piece, lay a 0.5mm non-conductive shim over the test piece and then repeat Step 5.

7. **Repeat using 1mm Shim.** Remove the probe from the test piece, lay a 1mm (or two 0.5mm) non-conductive shim over the test piece and then repeat Step 5.
8. **Repeat using 1.5mm Shim.** Remove the probe from the test piece, lay a 1.5mm (or three 0.5mm) non-conductive shim over the test piece and then repeat Step 5.
9. **Repeat using 2mm Shim.** Remove the probe from the test piece, lay a 2mm (or four 0.5mm) non-conductive shim over the test piece and then repeat Step 5.
10. **LOGC Configured or LOGC Failed.**
 - a. **LOGC Configured.** LOGC has been successful. To test this, run the probe over the 1mm defect with and without the 2mm shim, the defect should rise to the same height on the screen for each, indicating that the instrument is automatically adjusting the gain depending on the amount of Probe Lift-Off. If the defect height is much higher WITH the Shim, hold the probe on the test block and shim away from the defects and press the BALANCE key. Only the defect channel is balanced and all should now be good. On the Quick Menu bar there will be a number displayed above the microSD card icon. This is an estimation of the Lift-Off being measured in mm and can be easily checked using various Shims. This value may drift over time. As a rough guide, if the error is greater than +/- 0.5mm, re calibrate the LOGC.
 - b. **LOGC Failed.** From time to time the calculations performed after LOGC has been completed throw up an error in the calibration routine. This error can be related to the orientation of the probe, pressure applied to the probe or even the wrong shim used. Usually performing the LOGC Calibration once more will correct the problem.

4.2.2.5.1 Lift Off Gain Control Paint Alarm

Once LOGC has been calibrated, the Lift-Off Channel (Left pane) can be used to measure and therefore trigger an alarm if the Paint Thickness (or Lift-Off) goes out of specified limits.

In the **Lift Off Gain** menu there are two parameters, **Max Paint** and **Min Paint** that must be configured to use this feature. For example, setting the Min to 1.0mm and the Max to 1.8mm will cause an Alarm Box to be displayed on the Lift-Off pane that is scaled to represent these measurements. The alarm will then trigger if this Lift-Off spot is OUTSIDE of this 1.0 to 1.8mm range.

To remove the Alarm, set the **Min Paint** and **Max Paint** to be equal.

4.2.2.6 Mix

The mix channel is the output of the subtraction of Channel 2 from Channel 1. The parameters allow that signal to be adjusted as required.

- Phase: Mix Channel phase adjustable from 0.0-359.9 degrees with 0.1 degree precision
- Gain X: Horizontal gain in dB -18 to + 82 dB Range Settable to 0.1dB resolution.
- Gain Y: Vertical gain in dB -18 to + 82 dB Range Settable to 0.1dB resolution.
- Gain Lock: which may be set of (X and Y Gain are individually adjustable), Y=X; both gain values are equal and Fixed: where the dB ratio between the X/Y values is kept a constant difference (and hence the X/Y signal ratio remains constant).
- Increment: Sets the adjustment precision to either 0.1, 1 or 6dB

4.2.2.7 Summary

This item shows a single screen view of all the instruments current settings.

4.2.3 Configure Pane

4.2.3.1 Appearance

- Backlight: 10-100% lower backlight setting gives substantially longer battery life.
- Scheme: Bright = Good for outdoor use, Dark=Good for indoor use and Black & White
- Font: Bold or Italic Text
- Screen Flip: Right Handed, Left Handed or Auto (uses internal sensor to set orientation)

4.2.3.2 Power Save

- Auto Power Off: Off, 5-60 mins.
- Auto Screen Dim: Off, 5-60 mins

4.2.3.3 Time and Date

- Time/Date- adjust as per other parameters
- Format- Allows selection of date format from DD/MM/YY, MM/DD/YY or DD Mmm

4.2.3.4 Language

Selectable from English, French, Spanish, Italian, Portuguese, Russian, Japanese, Chinese, Turkish, Czech, and Norwegian.

4.2.3.5 Load & Save.

Select this function by highlighting the item and pressing enter.

The main screen shows the saved settings (each blue square represents a save attachment). Use the up down cursor keys to change which saved setting is highlighted (red box) and press Enter to see a brief summary of the settings and Enter a second time to Load.

The functions of the icons are as follows;

Recall from memory →

Rename setting slot →

Save current settings to memory slot →

Delete current settings slot →

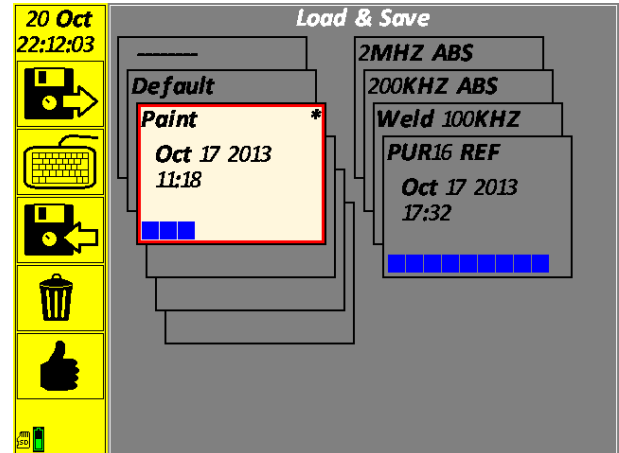

Make current Settings slot a favourite. Up to five settings may be set as favourites.

To create a new setting select the empty setting (with no name) and press enter.

A setting that has been selected as a favourite has an asterisk (*) in the top right hand corner. Favourite settings will appear on the opening screen and provide a convenient way of quickly using the most commonly used settings.

If no favourites are set then the instrument when powered up will start up in the Operating screen and use the last settings used.

The blue squares on the Setting Item indicate that there are screen shots associated with this setting. Red squares indicate that there are data recordings.

4.2.3.6 About

Important information about the instrument, including: Firmware Version, Current Slot, Manufactured Date and Instrument ID

4.2.3.7 Lock

The WeldCheck+ has the ability to restrict access to any menu item. Any menu item that has a picture of a Padlock after its name is locked.



This means that its value can be read but not adjusted.

Some menu items such as Load/Save can still be entered but if locked then files can only be loaded and not saved or deleted.

Locking and Unlocking Process

Entering Lock Mode - First, to change the locked status of a Menu Item the instrument must be in LOCK mode. To enter this mode first select the Menu Item LOCK within the CONFIGURE Menu Group. The user will now be prompted to enter the LOCK code. This code is entered by using the **Up**, **Down**, **Left**, **Right** keys. By default the code is **L, L, U, D, L**. Once entered correctly the Lock Menu will display the instructions to Lock and Unlock Menu items, which are repeated below.

Locking/Unlocking - Once in Lock Mode the Lock status of a Menu Item is toggled by highlighting the Menu Item and then holding down the Menu/Back key. Once the desired Menu Items have been set the machine must be rebooted to leave Lock Mode.

4.2.4 Display Pane

4.2.4.1 Graticule

Settings for the display graticule for pane 1 and pane 2

- Type: None, Grid, Polar, Timebase or Meter (context sensitive).
- Size: 5 – 50 % in 5%

4.2.4.2 Spot

Settings for how the spot is drawn to the screen in Pane 1 and Pane 2

- Size: To enhance the spot visibility choice of 1*1, 2*2 or 3*3 pixels
- Colour: Sets spot colour
- Co-ordinates: Displays numeric position of spot None, X,Y or Theta,R

4.2.4.3 Offset

Offset: Spot position offset for pane 1 and 2 in %.

4.2.4.4 Persistence

Persistence and Time-base settings for Pane 1 and Pane 2

- Persistence – Time in Seconds that a point is visible in X-Y mode.
- Sweep – Time taken for a single sweep across the screen in Timebase mode.
- TB Sweeps – Number of continuous Sweeps that are visible before being removed in Timebase mode.
- Steps – The number of Steps that are visible in Waterfall mode.

4.2.4.5 Panes

Each Pane can have different Sources and Different type

- Pane 1: XY, Time-base, Waterfall and Meter with peak hold and percentage.
 - Source = Ch1, Ch2 or Mix with two sources possible
- Pane 2: Off, XY, Time-base, Waterfall and Meter with peak hold and percentage
 - Source = None, Ch1, Ch2 or Mix with only one source possible. Note: If Pane 1 has two sources then Pane 2 cannot be on.
 - Size: Size 5-50%
Note: 50% = Equal sized left and right displays
 - Location: Up/Down to move Pane 2 position. Selectable from Top right, Bottom Right, Bottom Left, Top Left.

4.2.5 Advanced Pane

The advanced pane is where all the special functions of the instrument are located.

4.2.5.1 Alarm

Alarm: Audio and Visual Alarm

- Source:
 - 1&2 – Acts on both channels with alarm out put logically OR ed
 - 1- channel 1
 - 2- channel 2
 - Mix- mix channel
- Action: Audio Alarm, Freeze, Audio Alarm and Freeze, LED only (no freeze or audio)
- Stretch: Time alarm stays on after activation from 500ms to 10s.

4.2.5.2 Alarm Zones

- Type: Off, Sector, Box
- If Sector then;
- Inner
 - Outer
 - Start
 - Stop
- If Box then;

- Top
- Bottom
- Left
- Right

4.2.5.3 Attachments

Attachments are either screen shots (Picture) or recordings. By default a screenshots file name is a date and time stamp with the date in reverse numerical order, this ensures that files are displayed in chronological order.

Load selected screen shot or recording →

Rename selected attachment →

Delete selected screenshot or recording →

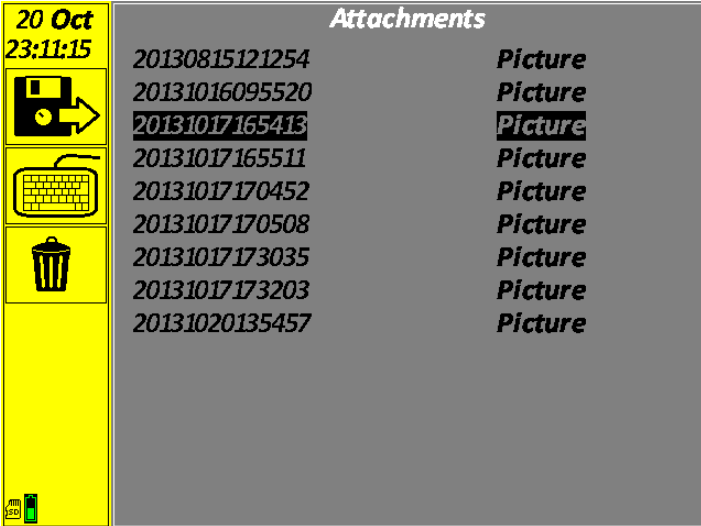

20 Oct 23:11:15		<i>Attachments</i>	
	20130815121254		<i>Picture</i>
	20131016095520		<i>Picture</i>
	20131017165413		<i>Picture</i>
	20131017165511		<i>Picture</i>
	20131017170452		<i>Picture</i>
	20131017170508		<i>Picture</i>
	20131017173035		<i>Picture</i>
	20131017173203		<i>Picture</i>
	20131020135457		<i>Picture</i>

Note: Screen shots and Recordings are saved to the SD card in order to appear on the Attachments Menu they must be saved with the setting they are associated with.

To return to the Operating screen after recalling a screen shot press any key.

4.2.5.4 Guide Tool

The Guide Tool allows presentations uploaded to the instrument using ETher Realtime Software to be viewed on the instrument whilst performing an inspection.

Once entering the Guide Tool a menu showing all the available guides is shown. The Asterisk (*) denotes that this is the previously selected favourite for the currently recalled settings. Up/Down cursor keys highlight different guides. Pressing OK will show a description in the red box at the bottom of the screen.

Select this Icon and press OK to display the guide as a slide show.

Select this Icon and press OK if you need to display individual files in the Guide.

Use this icon to make the currently highlighted Guide a favourite.

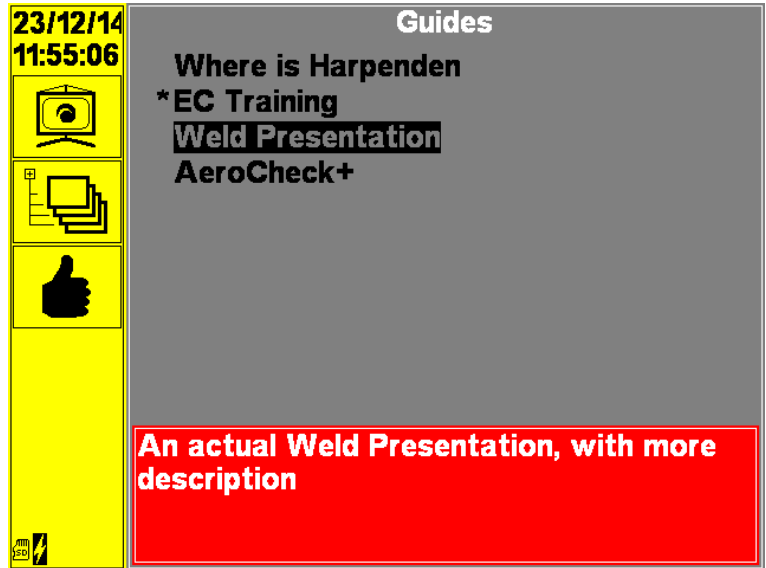

When a Guide is being displayed pressing OK will

make the control bar appear.

Use the left/right cursor to highlight an icon and then press OK to activate.



Select the play icon to begin guide play back.



The symbol will then toggle to the pause play back.



= Return to start



= Advance one slide (same as right cursor key)



= Go back one slide (same as left cursor key)



= Go to end



= Exit Guide temporarily

To exit a Guide permanently press the Back/Menu Key.



= Select and then cursor up/Down alters duration between each slide in a guide being displayed.

If a Guide is exited temporarily then the Guide Icon appears in the Menu Side Bar.

Selecting the Guide Icon (Book) then causes a lower tool bar to appear that gives the option of returning to the Show or Exiting the Show.

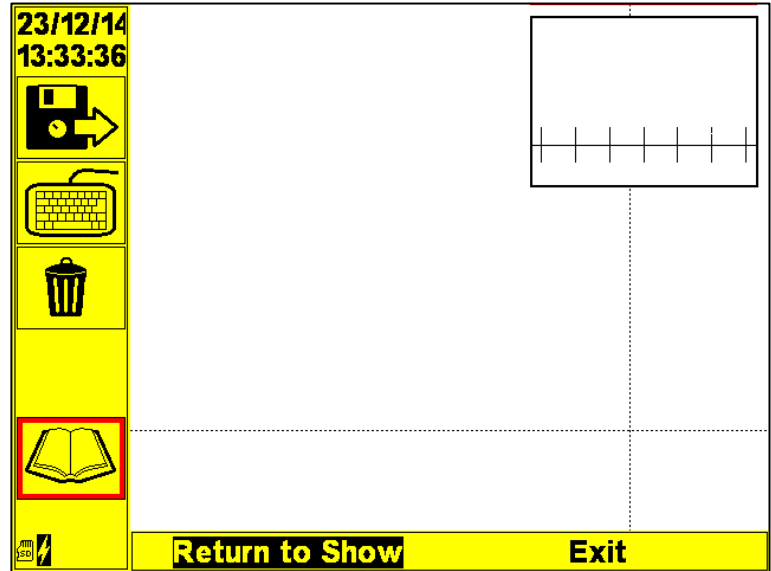

4.2.5.5 Record & Replay Function

The Record & Replay Function allows data to be captured for up to 150s. This data may then be saved on the instrument, replayed either on the instrument or transferred to a PC and analysed using the utility ETherAnalyser. Captured data can be analysed in greater detail by zooming in on the collected data and also a recording can be used to optimise the equipment settings such as Filter, Gain and Phase in a consistent matter.

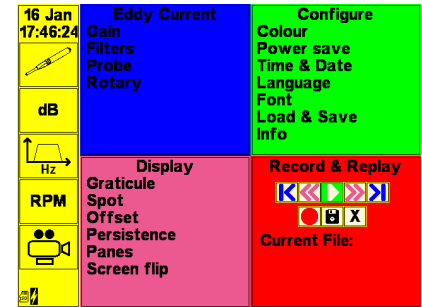

1. To use this sequence first place the Record & Replay Icon on the Side Bar (see 5.2.1)

2. Then return to the operating screen and select the Record & Replay



Icon (camera).

3. A special tool bar will be displayed at the bottom of the screen. Top right is the data sample rate used for the data recording. During the recording a grey cursor moves across the screen and the time display on the right is updated. The Grey cursor width indicates the time duration of the on screen persistence). The activity symbol (lower right) is

animated to indicate activity.

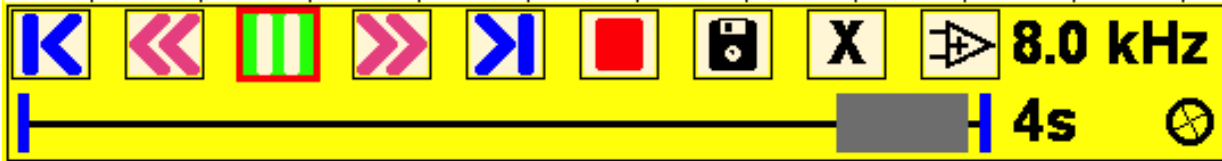

4. Using the cursor keys and the Enter Key select the item required. A red box surrounds the symbol selected.



The Record Item Symbol toggles between the record state and the stop state. Select to record (note when selected the Icon Colours Reverse to denote the symbol is selected).



When the symbol is selected it changes to the Stop Symbol and the recording continues until is selected again. Should the recording length be exceeded the recording is always of the last 150 seconds.



Select the play icon to begin data replay.



The symbol will then toggle to the pause symbol.

Whilst a recording is playing there are several functions that can be used to view the recording.



= Return to start



= Slow down replay



= Speed up replay



= Fast Forward to end

You can also leave the recording function using the Back Key and the recording will continue running. This then allows settings to be altered and the result viewed. This can be useful when calibrating in a dynamic test as the data settings be optimised off-line. To return to the Record & Replay function then select the Record & Replay Icon.



To zoom in on a specific part of the recording move the blue cursor bars at each end of the recording. Press the down cursor key and the left or right to select a cursor. The selected cursor turns red when selected. Then press the Enter key and the cursor turns green. Use the left and right keys to move the cursor. The display on the right

shows the cursor position in time. When in the correct position press the Enter key again and the colour of the highlighted cursor changes from green to red. Use the cursor keys to move the selection focus to the required cursor. Then press Enter and use the Left and Right cursor keys to select the other cursor.



= Save recording. The User is prompted for a file name. Saved record may be replayed at any time by loading the item in the Attachments function see 5.2.5.3 Recordings are saved to the SD card in order to appear on the Attachments Menu they must be saved with the setting they are associated with.



= Exit Record & Replay Function and return to the Operating screen.



= Auto mix function. Record a signal to suppress and press the centre enter key for the instrument to automatically derive the optimal mixing coefficients.

4.2.5.6 Auto Phase

This provides an automatic means of setting the phase in any required orientation.

- Angle: the required angle measured from the usual 9 o'clock lift off position as zero degrees and then rotating clockwise.
- Radius: Sets the threshold crossing for the phase setting to be triggered at.
- Set one of the user programmable soft keys to activate this function.

5 Setting the WeldCheck+ to perform an inspection

5.1 *With a configuration file*

If you have a configuration file for the probe, load the setting file as described in section 5.4. It is a recommended practice to validate that the settings loaded by the software are correct for the probe type. To do so press MENU, go on the Probe and Frequency tab, and verify the settings. Then following this ensure that the response from the calibration reference standard is as per the procedure the inspection is being performed to. Press MENU when finished.

5.2 *With no configuration files*

1. First press the MENU,
2. Set the gain to about 40 dB. Make sure the Gain Lock is set do $Y=X$.
3. Set the Probe; set the Type. Load and Frequency as required.
4. Set the filters for manual inspection as High Pass = DC and Low Pass = 300Hz
5. Set the display type you require to use with the Display configuration.
6. Adjust the gain and phase to obtain the response required by the inspection procedure.

5.3 *Sample application setup*

By default the instrument has a number of factory settings.

These may be reviewed in the Load & Save function

- Weld – 100kHz setting for weld inspection
- Paint – 100kHz using Lemo 00 for paint coating assessment as in Weld Inspection
- Weld Dual Probe - 100kHz settings for Weld and Paint Inspection
- Weld Single Probe Dual Channel – 100kHz setting to use a Weld Probe for both inspection and paint thickness.
- 2MHz Absolute – using the Lemo 00 for Surface defect detection
- 200kHz Absolute – using the Lemo 00 for Surface defect detection
- 500kHz Absolute – using the Lemo 12 way for Surface defect detection
- PUR16 Reflection – Low Frequency 10kHz for sub-surface testing on non-ferrous material
- ID Probe-Mix -21kHz and 18kHz ID Tube inspection mix

The above settings may be used as a starting point for a wide range of inspections using.

5.3.1 Weld Probe Single Setting

These notes are offered as a guide to help carry out a Weld Probe Inspection.

5.3.1.1 Equipment Required

Lead, Lemo 12-Way to Lemo 4-Way Bridge Type – ALL12-L04-015B

100kHz Weld Probe Bridge – PWM100S000

Steel Test Block with 3 slots 0.5, 1.0, 2.0mm and 4 - 0.5 mm shims - ATBW

5.3.1.2 Setup

1. Connect probe to cable and connect to the instrument.
2. Switch instrument on.
3. Use the cursors to scroll the menu until Load & Save is highlighted, press Enter key. Use the up down cursor to select Weld 100kHz, select the load icon and press Enter
4. The main Operating screen will appear as soon as the setup has been recalled.
5. Place the probe on the test block and Press Balance
6. Move the probe over the defects.
7. If more or less sensitivity is required, use the Gain (dB key) or Quick-Menu to increase or decrease signal amplitude as required.
8. Adjust the phase to set the defect signal vertical by either using the Probe Phase Item or the Quick-Menu
9. Carry out scan of component.

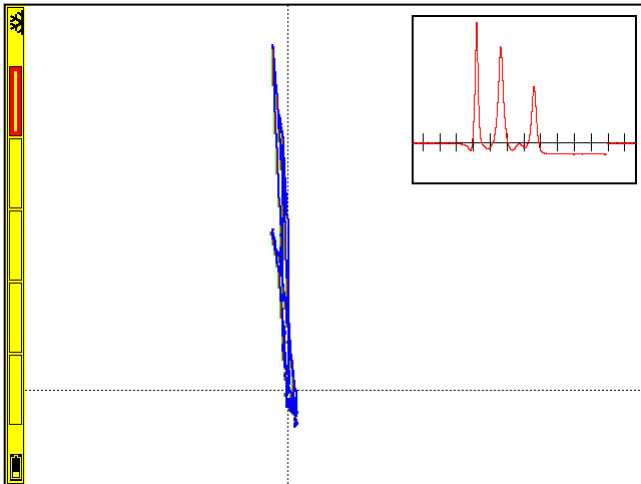
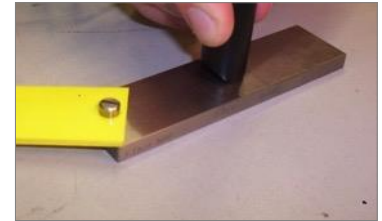

5.3.2 Paint Probe (Weld Setting)

These notes are offered as a guide to help carry out a dual channel Weld Probe Inspection.

5.3.2.1 Equipment Required

Probe, Unshielded, Broad Band, 100k - PUB100K

Accessory, Lead. Lemo 00 to BNC, 1.5m - ALLCX-B02-015A

Steel Test Block with 3 slots 0.5, 1.0, 2.0mm and 4 - 0.5 mm shims - ATBW

5.3.2.2 Setup

1. Connect probe to cable and connect to the instrument.
2. Switch instrument on.
3. Use the cursors to scroll the menu until Load & Save is highlighted, press Enter key. Use the up down cursor to select PAINT WELD, select the load icon and press Enter
4. The main Operating screen will appear as soon as the setup has been recalled.
5. Place the probe on the test block and Press Balance
6. Select the offset Icon on the front panel.
7. Adjust gain and phase as required to set the lift off vertical by either using the Probe Phase Item or the Quick-Menu

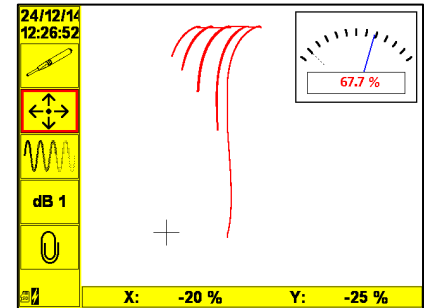

8. Then moving the X Offset create the trace for the 4 shims
9. Set Trace function on and store trace (this gives a black version of the image) to enable easy comparison.

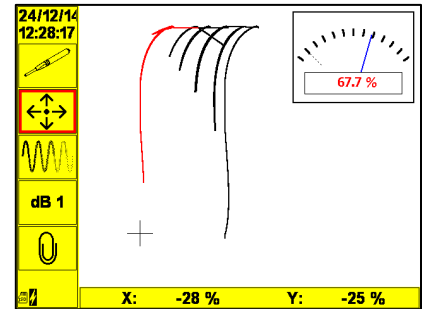

5.3.3 Weld Inspection with two probes

These notes are offered as a guide to help carry out a dual channel Weld Probe Inspection using 2 probes. This allows the operator to set the instrument for Weld Inspection

5.3.3.1 Equipment Required

Lead, Lemo 12-Way to Lemo 4-Way Bridge Type – ALL12-L04-015B

100kHz Weld Probe Bridge – PWM100S000

Probe, Unshielded, Broad Band, 100k - PUB100K

Accessory, Lead. Lemo 00 to BNC, 1.5m - ALLCX-B02-015A

Steel Test Block with 3 slots 0.5, 1.0, 2.0mm and 4 - 0.5 mm shims - ATBW

40710_02 User Manual for WeldCheck+.docx

5.3.3.2 Setup

1. Connect probes to cable and then connect both to the instrument.
2. Switch instrument on.
3. Use the cursors to scroll the menu until Load & Save is highlighted, press Enter key. Use the up down cursor to select Weld Dual, select the load icon and press Enter
4. The main Operating screen will appear as soon as the setup has been recalled.
5. Place the probe on the test block and Press Balance
6. Move the probe over the defects.
7. If more or less sensitivity is required, use the Gain (dB key) or Quick-Menu to increase or decrease signal amplitude as required.
8. Adjust the phase to set the defect signal and lift off signal vertical by either using the Probe Phase Item or the Quick-Menu
9. Carry out scan of component. NOTE: Left pane shows differential channel 2 and right pane absolute channel 1.

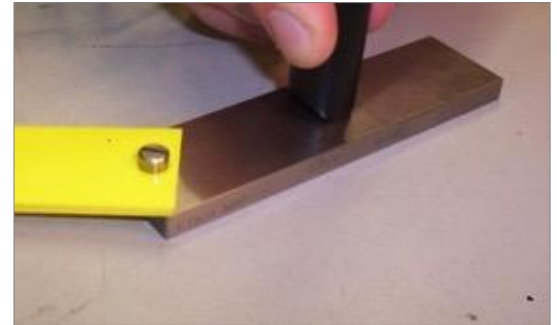

10. Alternatively you may set the weld probe to be both Differential (normal flaw detection) and coating thickness assessment by changing the probe type to ABS&DIFF INTERNAL. NOTE: the load setting for the 100kHz WeldProbe to work in absolute is 12uH.
11. Further if more convenient Pane 2 can be set to Meter or Time and made to occupy a smaller part of the screen e.g. 30%

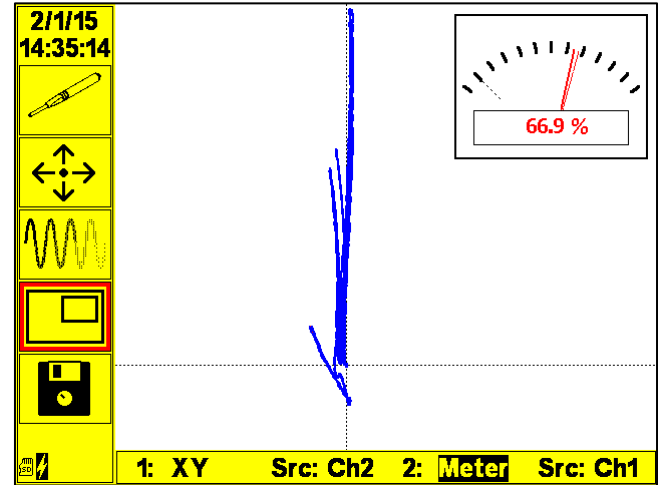
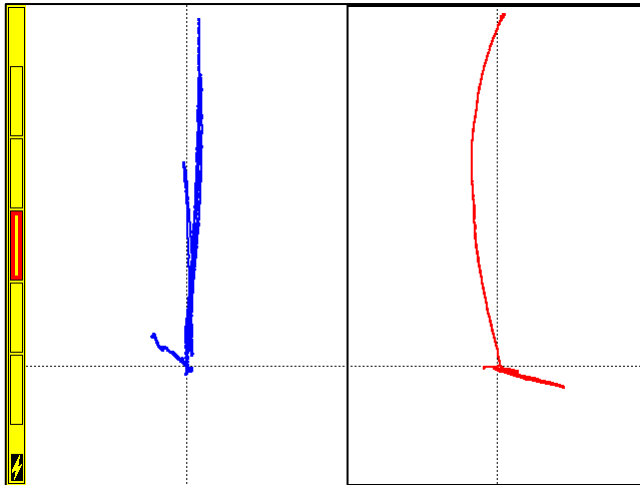

5.3.4 Weld Single Probe Dual Channel

These notes are offered as a guide to help carry out a dual channel Weld Probe Inspection using 2 probes. This allows the operator to set the instrument for Weld Inspection

5.3.4.1 Equipment Required

Lead, Lemo 12-Way to Lemo 4-Way Bridge Type – ALL12-L04-015B

100kHz Weld Probe Bridge – PWM100S000

Steel Test Block with 3 slots 0.5, 1.0, 2.0mm and 4 - 0.5 mm shims - ATBW

5.3.4.2 Setup

12. Connect probe to cable and then connect to the instrument.
13. Switch instrument on.
14. Use the cursors to scroll the menu until Load & Save is highlighted, press Enter key. Use the up down cursor to select **Weld Dual**, select the load icon and press Enter
15. The main Operating screen will appear as soon as the setup has been recalled.
16. Place the probe on the test block and Press Balance
17. Move the probe over the defects.

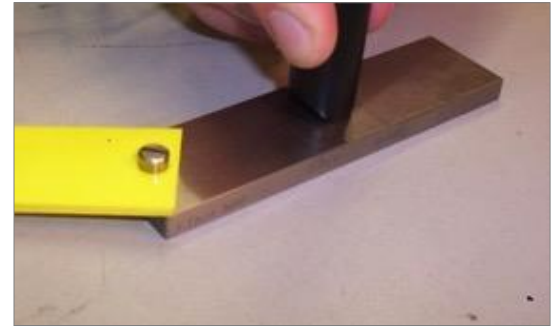

18. If more or less sensitivity is required, use the Gain (dB key) or Quick-Menu to increase or decrease signal amplitude as required.
19. Adjust the phase to set the defect signal and lift off signal vertical by either using the Probe Phase Item or the Quick-Menu
20. Carry out scan of component. NOTE: Left pane shows differential channel 2 and right pane absolute channel 1.

21. Alternatively you may set the weld probe to be both Differential (normal flaw detection) and coating thickness assessment by changing the probe type to ABS&DIFF INTERNAL. NOTE: the load setting for the 100kHz WeldProbe to work in absolute is 12uH.
22. Further if more convenient Pane 2 can be set to Meter or Time and made to occupy a smaller part of the screen e.g. 30%

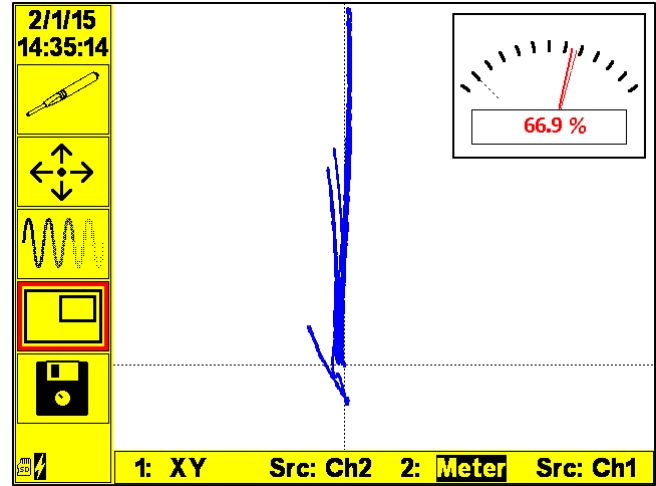
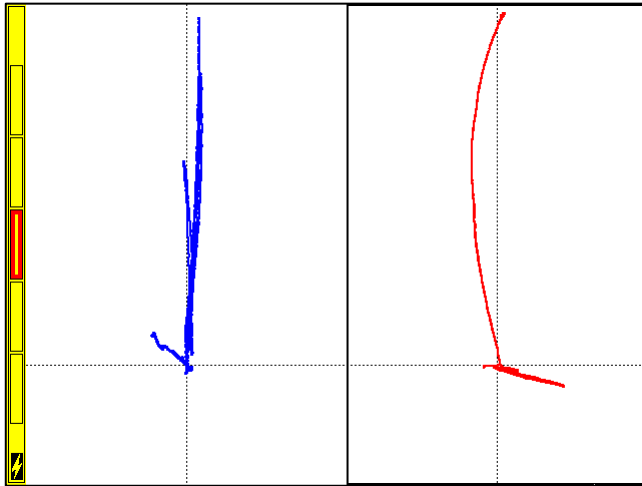

5.3.5 High Frequency Surface Inspection

These notes are offered as a guide to help carry out a test for surface inspection using High Frequency Eddy Currents. There are three high frequency surface inspection tests on the instrument;

- 2MHz Absolute – using the Lemo 00
- 200kHz Absolute – using the Lemo 00
- 500kHz Absolute – using the Lemo 12 way

5.3.5.1 Equipment Required:

Probes and cables;

- 200kHz Absolute - PS200PD064-114N and Lead, Lemo 00 to Microdot - ALLCX-M02-015A
- 500kHz Absolute – PS500PC195-114N and Lead, Lemo 12-Way to Microdot – ALL12-M02-015A
- 2MHz Absolute – PS002PS066-152N and Lead, Lemo 00 to Microdot - ALLCX-M02-015A

Test Blocks;

- Aluminium 7075-T6 with 3 slots 0.2, 0.5, 1.0mm – ATBA
- Titanium with 3 slots 0.2, 0.5, 1.0mm – ATBT
- Stainless Steel with 3 slots 0.2, 0.5, 1.0mm – ATBS
- Ferrous Steel (EN1A) with 3 slots 0.2, 0.5, 1.0mm – ATBF
- Magnesium with 3 slots 0.2, 0.5, 1.0mm – ATBM
- Steel with 3 slots 0.5, 1.0, 2.0mm and 4 off 0.5 mm shims (Weld Inspection)- ATBW

5.3.5.2 Setup:

1. Connect probe to cable and connect to the instrument.

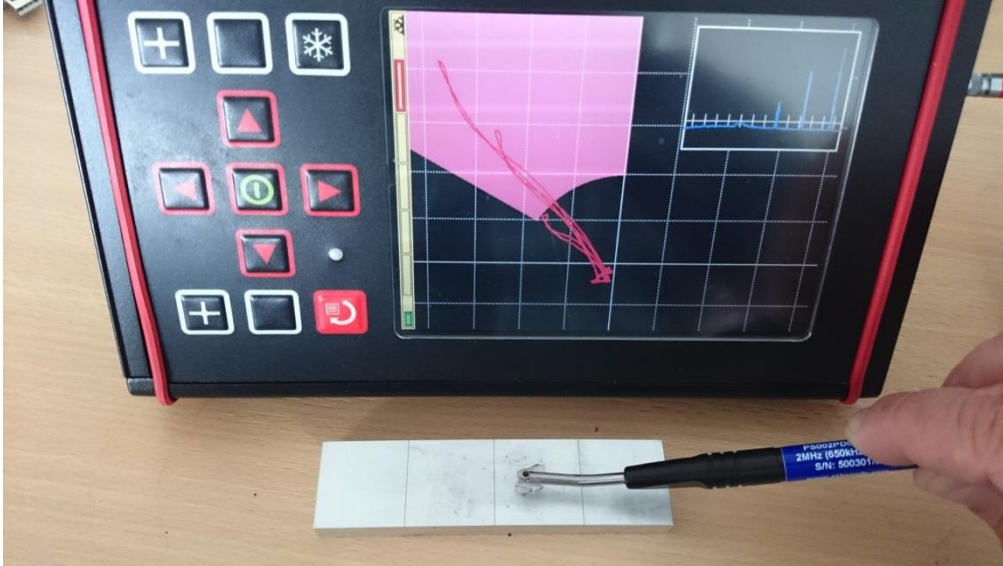

2. Switch instrument on.
3. Press Menu.
4. Use the cursors to scroll the menu until Load & Save is highlighted, press Enter key. Use the up down cursor to select Required Setup, select the load icon and press Enter

5. The main Operating screen will appear as soon as the setup has been recalled.
6. Place the probe on the Reference Standard (away from EDM notches) normal (90°) to the surface
7. First set the load using the Auto Load Option in the Probe Menu and assign one of the soft keys (see 2.3.2)
8. Then carry out Balance/Lift off function setting Auto Phase under advanced at 0 degrees and radius 50%. Then assign the other soft key to Auto Phase.
9. Scan the probe over the 0.5 mm EDM notch and note signal response.
10. If more or less sensitivity is required, use the Gain (dB key) or Quick-Menu to increase or decrease signal amplitude as required.
11. Adjust the phase to set the lift off horizontal by either using the Auto Phase Key (assigned above) or Probe Phase Item or the Quick-Menu Phase Item.
12. Carry out scan of the component.

Note:

1. If you use a different Frequency probe remember to adjust Frequency setting on the instrument to match the probe. The balance load will also need to be set to match the probe see 5.2.2.1
2. Where possible always use a Reference Standard, which is a similar material to that which is to be inspected.
3. Always try and keep the probe normal (90°) to the surface of inspection, especially if scanning in a radius.

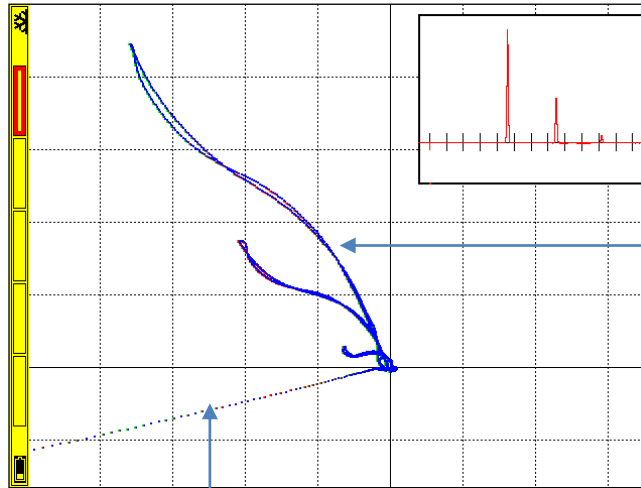

Three Notch Responses

Lift off

5.3.6 Low Frequency Sub-Surface Inspection

These notes are offered as a guide to help carry out a test for low frequency sub-surface inspection using Low Frequency Eddy Currents.

5.3.6.1 Equipment Required:

Probes = 300Hz – 100kHz Reflection Probe – PUR16
Cable = Lead, Lemo 12-Way to Lemo 4-Way Reflection Type – ALL12-L04-015R
Test Piece = Aluminium Thin Plate – ATB001

5.3.6.2 Setup:

1. Connect probe to cable and connect to the instrument.
2. Switch instrument on.
3. Use the cursors to scroll the menu until Load & Save is highlighted, press Enter key. Use the up down cursor to select PUR16 REF, select the load icon and press Enter
4. The main Operating screen will appear as soon as the setup has been recalled.
5. Place the probe on the Reference Standard with the flat-bottomed holes facing downwards.



6. Then carry out Balance/Lift off function setting Auto Phase under advanced at 0 degrees and radius 50%. Then assign the other soft key.
7. Scan the probe over the defects and note signal response.
8. If more or less sensitivity is required, use the Gain (dB key) or Quick-Menu to increase or decrease signal amplitude as required.
9. Adjust the phase to set the lift off horizontal by either using the Probe Phase Item or the Quick-Menu
10. Carry out scan of component.

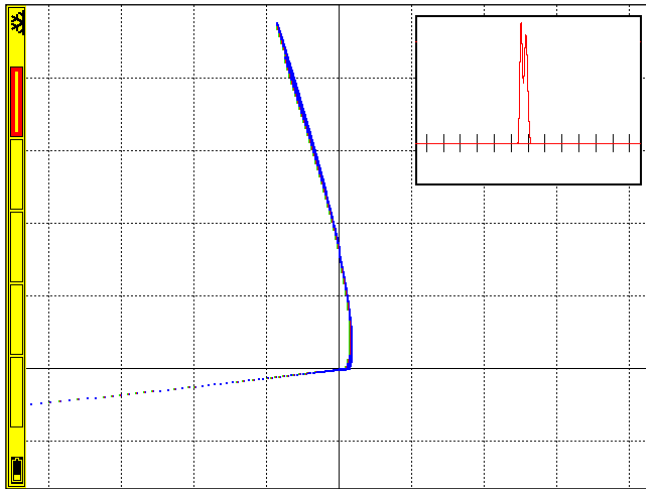

Note:

1. Use your finger as a guide along the edge of the test piece. This will help maintain the same probe to edge distance.
2. Always try and keep the probe normal (90°) to the surface of inspection.

5.3.7 Dual Frequency Mixing

5.3.7.1 Principle of mixing

The principle of dual frequency mixing is that at different frequencies different signal indications (e.g. lift off and defect) have a different relative phase and amplitude response. By means of phase rotation and Gain change of the X Y signal components one of these indications can be manipulated to be nearly the same in phase and amplitude as the other and then by subtraction (mixing) the unwanted component is minimised giving an improved detection of the unwanted signal. Channel 1 is the primary channel and as such is not manipulated in the Auto Mix process whereas Channel 2 is the secondary channel. It is good practise for the secondary channel to be set so that it is relatively more sensitive to the unwanted signal than the wanted signal.

Although this example is for a low frequency mix this is equally applicable to other absolute probe mixes and the procedure and principles are widely applicable.

NOTE; mixing inevitably causes an increase in the electronic noise (grass).

5.3.7.1 Example of mixing

The conventional example of mixing is to use a non-ferrous tube and minimise the affect of a ferrous support ring however here we demonstrate mixing out lift off on a low frequency test. This test uses 5kHz on Channel 1 and 20kHz on Channel 2.

5.3.7.2 Equipment Required:

Probes = 300Hz – 100kHz Reflection Probe – PUR16
Cable = Lead, Lemo 12-Way to Lemo 4-Way Reflection Type – ALL12-L04-015R
Test Piece = Aluminium Thin Plate – ATB001

5.3.7.3 Setup:

1. Connect probe to cable and connect to the instrument.
2. Switch instrument on.
3. Use the cursors to scroll the menu until Load & Save is highlighted, press Enter key. Use the up down cursor to select DUAL SPOT MIX, select the load icon and press Enter
4. The main Operating screen will appear as soon as the setup has been recalled.
5. Place the probe on the Reference Standard with the flat-bottomed holes facing downwards.
6. Then carry out Balance/Lift off function setting Auto Phase under advanced at 0 degrees and radius 50%. Then assign the other soft key.
7. Scan the probe over the defects and note signal response.
8. If more or less sensitivity is required, use the Gain (dB key) or Quick-Menu to increase or decrease signal amplitude as required.

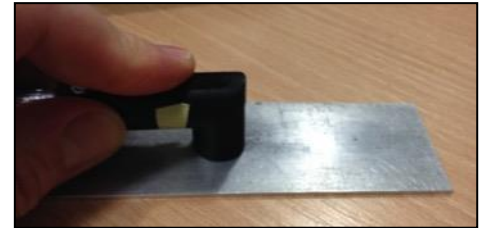

9. Set the panes to display channel 1 and channel 2 as shown.

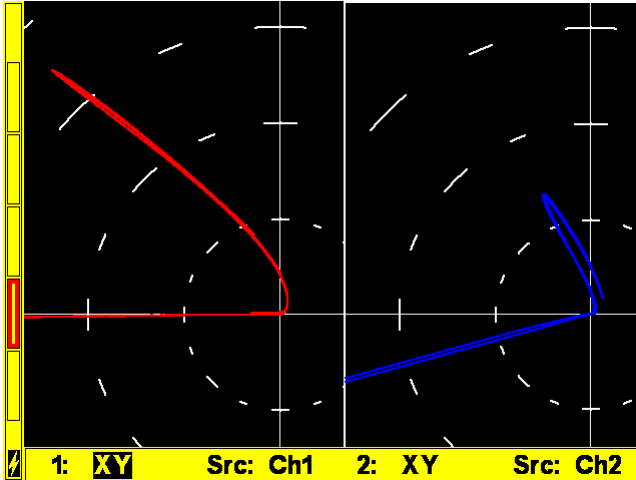

10. Repeat the setting for channel 2 so that the display looks similar to that above.

11. Now in the Record function record the lift off whilst gently rocking the probe. Press Stop to complete.



12. Then select the Auto Mix function

13. Once the message "Auto Mix Complete" is displayed return to the operating screen by selecting Exit



14. The display will now look like this

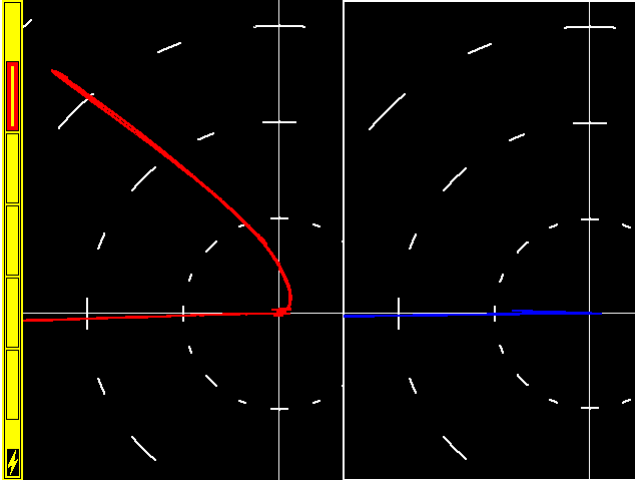

15. Now adjust the Pane setting to show the Mix channel in pane 2.

16. Adjust the Mix phase to set the signal as required by either using the Probe Phase Item or the Quick-Menu.

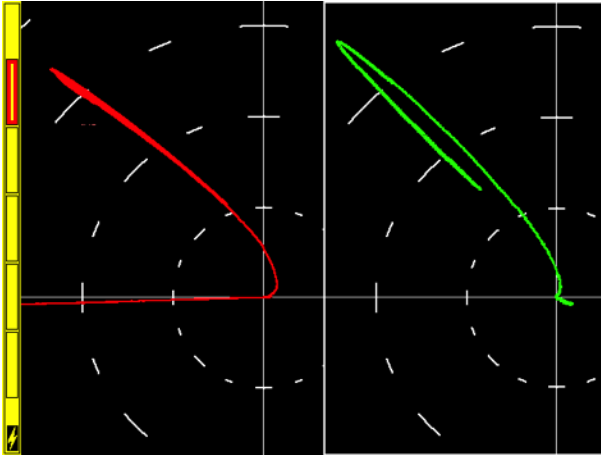

17. The mix is now complete

Note:

1. Use your finger as a guide along the edge of the test piece. This will help maintain the same probe to edge distance.
2. Always try and keep the probe normal (90°) to the surface of inspection.

5.3.8 Conductivity

These notes are offered as a guide to help carry out a conductivity inspection using probe PCON001. The probe has an internal memory that stores the probe characteristics for calculating conductivity. Only one test frequency can be applied to a probe.

5.3.8.1 Equipment Required

Probe, Conductivity, 60kHz, Dia 13.00mm, Straight, Lemo 7-Way (AeroCheck Plus) – PCON001
Accessory, Lead, 12-Way Lemo to 7-Way Lemo, 0.7m, Conductivity – ALL12-L07-007-CON
Accessory, Dual Conductivity Reference Standard – ASIG010
REFERENCE HOLDER - Dual Conductivity Standard, (Thermal Bridge for Stability) - 40517

5.3.8.2 Setup:

1. Switch instrument on.
2. Connect probe to cable and connect to the instrument.
3. Instrument will auto detect the probe and go into conductivity mode, as shown:

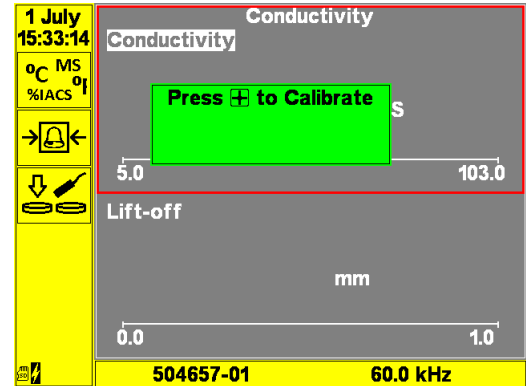

4. Press OK key to calibrate if the message box is shown, otherwise press left arrow and select the calibrate icon:



Scroll down and enter CB1 and CB2 %IACS values as shown on Dual Conductivity Reference Standard, press the back button, the unit will then go back to the main calibration screen.

5. Calibrate the probe by following the on screen prompts.

6. Once calibrated carry out measurement, example measurement shown:

7. Disconnect the probe cable and the conductivity mode will exit and the instrument will return to its normal operation mode.

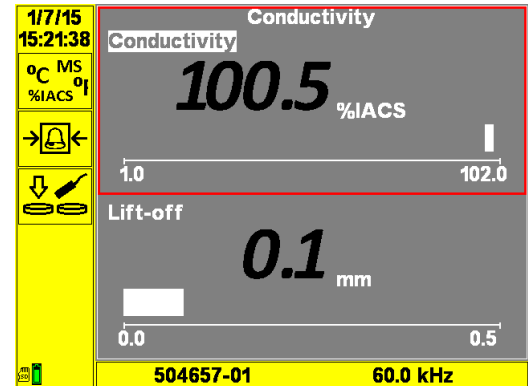
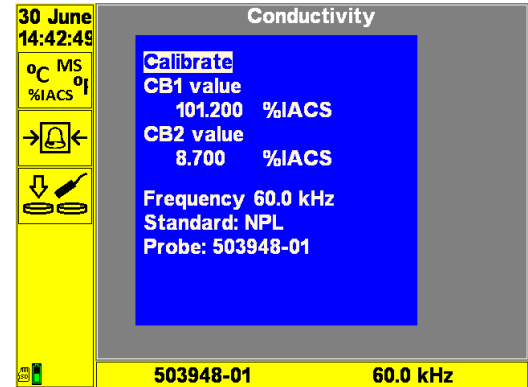

I. Additional Features

To Set display panes cursor right then up down to select pane to change then cursor right each key press changes display from Conductivity, Metal Sort, Minimum Thickness at measured conductivity and Lift Off/Non-conductive Coating thickness.



To set Units (both type and resolution) and Metal Sort select this icon with the cursor Key and press enter to open menu to set units display precision. Move up down left column to select Unit, Press Enter and then left right to select digit or item, up down to change and then enter to validate.



Sets the alarm range for both conductivity value and lift-off. First select the required display panes as the two displayed panes. Then select this icon with the cursor keys and press enter to select. The numeric value at the left end of the scale is highlighted press enter to edit the value. The Up Down Cursor Keys edit a digit and left right change the digit selected. Press enter to confirm selection. Press the right cursor key to move the selected numeric value and repeat the above procedure for each value to be edited.

Press the Back Key to exit this function.

II. Tips for Accurate Measurements

Always ensure that Probe, Dual Reference and Material to be tested are at the same temperature.

Re-calibrate the instrument every 15 minutes. There is a visual warning that the calibration needs to be repeated.

Frequent calibration is the key to accurate measurement.

Try not to hold the face of the probe, dual reference or material to be tested in your in your as this will change the temperature.

III. Specification

Accuracy

0.5%-10% IACS better than +/- 0.05% IACS

10%-25% IACS better than +/- 0.25% IACS

25%-60% IACS better than +/-0.5% IACS

60%-110% IACS better than +/- 1% IACS

Lift off corrected to 1.0 mm

No temperature compensation

All Errors at 90% Confidence Level

Resolution

3 decimal points max

Auto resolution mode AutoS= Legacy Instrument, Auto= SigmaCheck.

6 Weld Probe Data

6.1 *Standard Weld Probes - Bridge* Straight

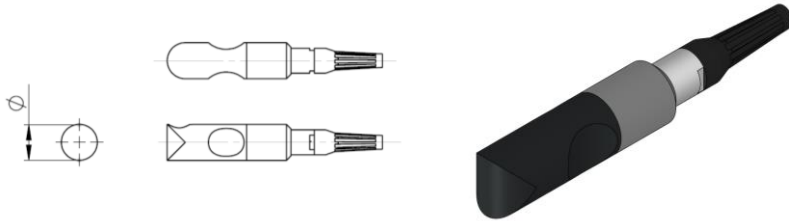

90deg Inline

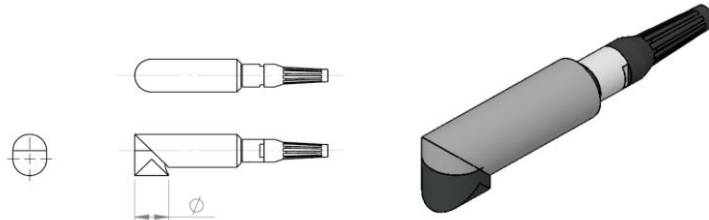

90deg Transverse

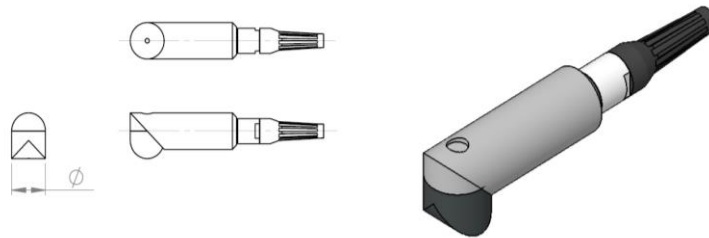

Application:

Differential Weld probes - for in-service inspection of welded structures.

Specification:

- Straight, 90deg Inline, 90deg Right Angle
- Diameters, 11.0 (Small), 16 (Medium), 32mm (Large)
- Disconnect able and integral probe cables
- Cable lengths from 1.5 to 50meters
- Frequency range 100, 20, 100-600kHz
- Minimal lift off signal, can find cracks though paint, oil and conductive and non-conductive coatings
- Made from hard wearing PET
- Stainless steel and ceramic tips available on request

Notes:

100kHz probes used on standard ferrous welds

100-600kHz probe can be used on Aluminium and Stainless Steel welds

20kHz probe can be used on multi-surface applications.

6.2 Standard Weld Probe Coding System

PWS100S015L12

PW	Probe Weld (Plastic)
S	Dia 11.0mm (Small)
M	Dia 16.0mm (Medium)
L	Dia 32.0mm (Large)
100	100kHz (Standard)
020	20kHz Enhanced
106	100-600kHz Multi-surface
S	Straight
I	90 deg Inline
R	90 deg Transverse
000	Disconnect
015	1.5m Cable
050	5.0m Cable
100	10.0m Cable

500 50.0m Cable

L7 7 Way Lemo

L12 12 Way Lemo

J6 6 Way Jaeger

A4 4-way Amphenol

C3 3-way Cannon

L14 14 Way Lemo

Example: PWS100S015L12

Part Number: Probe, Weld, Dia. 11.0mm (Small), 100kHz, Straight,
1.5m Cable, Lemo 12-Way.

Other options available on request.

Cables to fit above standard disconnect weld probes:

ETHer Part No	Description
ALL14-L04-015B	Accessory, Lead, 14-way Lemo to 4-Way Lemo, 1.5m cable, Vantage to Hocking (Bridge Probes)
ALL12-L04-015B	Accessory, Lead, Lemo 12-Way - Lemo 4-Way, 1.5m (Bridge)
ALL07-L04-015B	Accessory, Lead, Lemo 7-Way - Lemo 4-Way, 1.5m (Bridge)
ALJ06-L04-015B	Accessory, Lead, Jaeger 6-Way - Lemo 4-Way, 1.5m (Bridge)

6.3 Special Weld Probes - Bridge

Water Proof



ETher Part No	Frequency	Description
PWM100S500L12W	100kHz	Probe, Weld, Medium, Dia 16.00, 100kHz, Straight, 50m Cable, Lemo 12-Way, Water Proof
PWM100S500J6W	100kHz	Probe, Weld, Medium, Dia 16.00, 100kHz, Straight, 50m Cable, Jaeger 6-Way, Water Proof
PWL100S500L12W	100kHz	Probe, Weld, Large, Dia 32.00, 100kHz, Straight, 50m Cable, Lemo 12-Way, Water Proof
PWL100S500J6W	100kHz	Probe, Weld, Large, Dia 32.00, 100kHz, Straight, 50m Cable, Jaeger 6-Way, Water Proof
PWM100S1000L12W	100kHz	Probe, Weld, Medium, Dia 16.00, 100kHz, Straight, 100m Cable, Lemo 12-Way, Water Proof

PWM100S1000J6W	100kHz	Probe, Weld, Medium, Dia 16.00, 100kHz, Straight, 100m Cable, Jaeger 6-Way, Water Proof
PWL100S1000L12W	100kHz	Probe, Weld, Large, Dia 32.00, 100kHz, Straight, 100m Cable, Lemo 12-Way, Water Proof
PWL100S1000J6W	100kHz	Probe, Weld, Large, Dia 32.00, 100kHz, Straight, 100m Cable, Jaeger 6-Way, Water Proof

6.4 High Temp Ceramic Tipped

Straight

90deg Inline

90deg Transverse

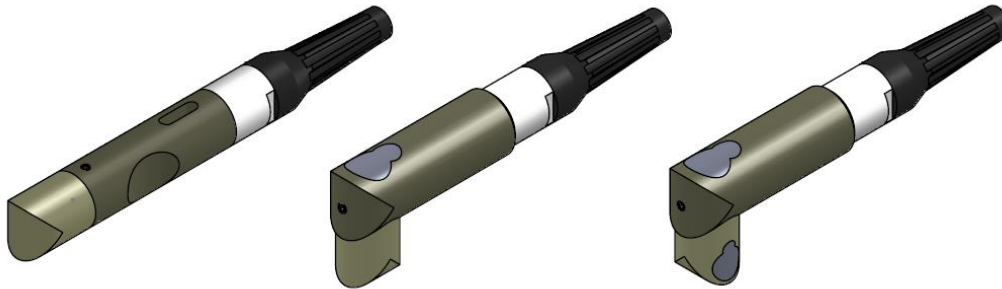

- In-service inspection of welded structures, works to a touch temperature of 200degC.
- Simply add a “C” to the end of a standard probe part number as shown on the previous page.

Example: PWS100S015L12C
Part Number: Probe, Weld, Dia. 11.0mm (Small), 100kHz, Straight,
1.5m Cable, Lemo 12-Way, Ceramic Tip, (High Temp)

Miniature

Straight

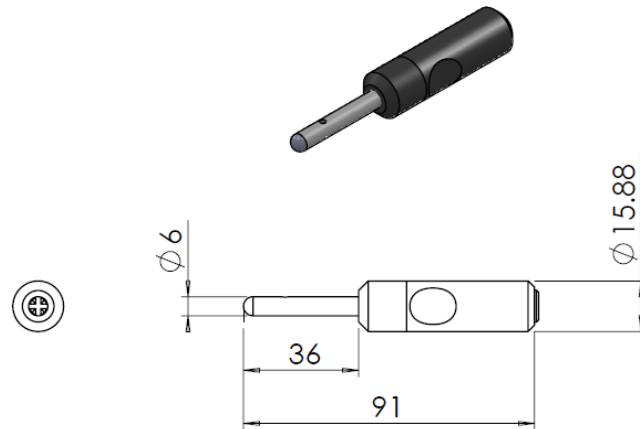

90deg Inline

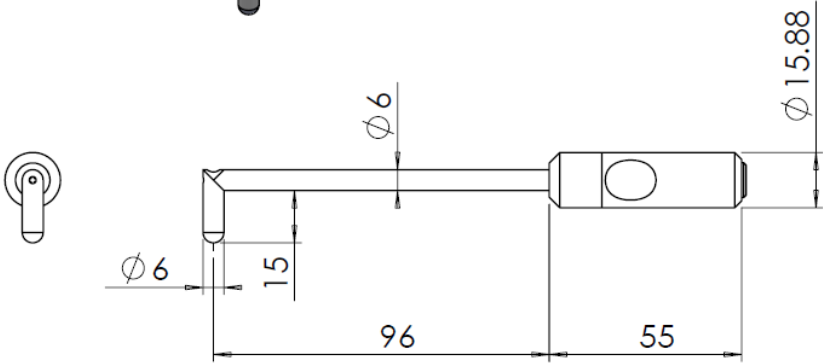
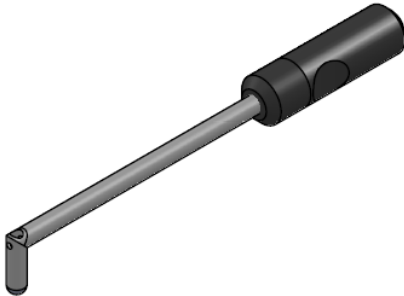

Cables to fit above standard disconnect weld probes:

ETHer Part No	Description
ALL14-L04-015B	Accessory, Lead, 14-way Lemo to 4-Way Lemo, 1.5m cable, Vantage to Hocking (Bridge Probes)
ALL12-L04-015B	Accessory, Lead, Lemo 12-Way - Lemo 4-Way, 1.5m (Bridge)
ALL07-L04-015B	Accessory, Lead, Lemo 7-Way - Lemo 4-Way, 1.5m (Bridge)
ALJ06-L04-015B	Accessory, Lead, Jaeger 6-Way - Lemo 4-Way, 1.5m (Bridge)

6.5 More Specials

Flat Faced



St Steel Dome Faced

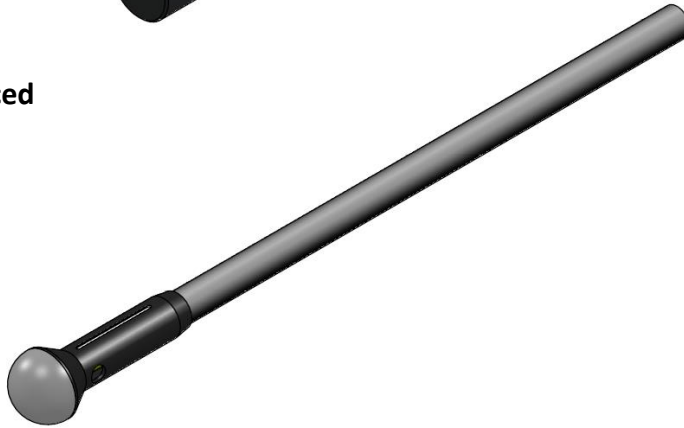

6.6 Broad Band/Paint Probes - Absolute

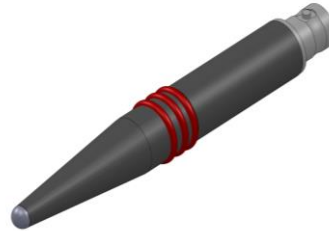

ETher Part No	Frequency	Description	Range
PUB2M	2MHz (5.6uH)	Probe, Unshielded, Broad Band, 2MHz	500kHz - 4MHz
PUB500k	500kHz (22uH)	Probe, Unshielded, Broad Band, 500k	150kHz - 1MHz
PUB100k	100kHz (82uH)	Probe, Unshielded, Broad Band, 100k	35kHz - 250kHz
PUB20k	20kHz (390uH)	Probe, Unshielded, Broad Band, 20k	7kHz - 60kHz
PUB5k	5kHz (1500uH)	Probe, Unshielded, Broad Band, 5k	2kHz - 15kHz

Cables to fit above standard disconnect weld probes:

ETHer Part No	Description
ALB02-B02-015A	Accessory, Lead, BNC Plug - BNC Plug, 1.5m (Absolute)
ALL12-B02-015A	Accessory, Lead, Lemo 12-Way - BNC Plug, 1.5m (Absolute)
ALL07-B02-015A	Accessory, Lead, Lemo 7-Way - BNC Plug, 1.5m (Absolute)

6.7 Test Blocks

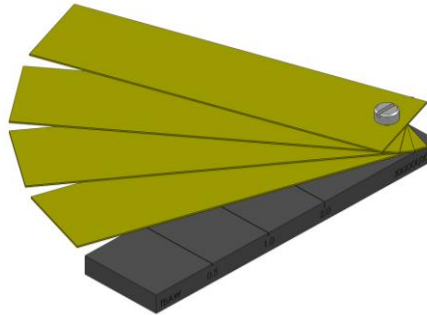

ETHer Part No	Frequency	Description
ATBW	Test Block	Accessory. Test Block, Weld Probe, Ferrous (Steel EN1A) + x4 0.5mm Shims, 0.2, 1.0, 2.0mm slots

7 Connectors

Connector 1

Model: Socket 12 Way Panel Mounted LEMO EEG2B312CNN (PCB PINS) –CLN

Mating Connector: Plug 12 way Free Lemo FGG2B312CLAD52Z

Pin	Name	Description	Note
1	FG0V	Generator 0v	
2	FGO/P	Generator output	
3	+VB	Battery Supply	
4	Motor –	Motor drive current return.	
5	Motor +	Motor drive current feed.	
6	OVD	Electrical ground (analogue).	
7	Diff+	Pick-up signal terminal. Positive.	
8	Diff–	Pick-up signal terminal. Negative.	
9	ENC	Encoder signal from rotating probe, one tick per turn.	
10	Gunsw/sck	Dual Use Gun Switch On/Off and also I2C bus clock	
11	Gun sda	GUN I2C bus data	

12	Gunalarm	Output of instrument flaw alarm	
----	----------	---------------------------------	--

Using the Voltage free alarm contact; there is a V-MOS FET connected between pin 6 (0VD) and 12 (Gunalarm). You will need to pull up pin 12 to a Power Supply (e.g. but not necessarily pin 3 (+VB)) with say a 10k resistor. You can also use an external supply but must make sure that its 0v is connected to Pin 6. **Note:** the maximum rating for the Transistor is 50v dc at 10mA.

Connector 2 (Lemo Coaxial)

Model: LEMO ERN.00.250.CTL

Mating connector: LEMO PCA.00.250.CTLC29Z

Pin	Name	Description	Note
1	0V	Ground (electrical connected to mechanical)	
2	SIGNAL	Bridge signal	

8 Software Update and System Recovery

8.1 Updating WeldCheck+ software

1. To update the WeldCheck+ software, the new file must be present on the micro SD Card in the instrument; this is accessible under the flap on the side of the instrument. The file is in the format EtherCheckv0000.hex.
2. There are 2 methods of getting the file on to the micro SD Card:
 - 1 Remove the card and place it in a micro SD Card Reader connected to a PC. Then use the PC to copy the file on to the card. The file **MUST** be in the **\EtherCheck** directory!!
 - 2 Use the PC package ETHERRealtime that is available from ETHERNDE for controlling and communicating with an WeldCheck+. See the section below on using ETHERRealtime to copy the file on to the micro SD card, again, ensuring that it is in the **\EtherCheck** directory.
3. Now that the file is present on the card and in the **\EtherCheck** directory:
 - Power OFF the WeldCheck+.
 - Hold the LEFT key and turn the WeldCheck+ ON using the POWER key. This will start the Boot Loader software and the screen will display “Searching for files...”
 - Below this, a list of compatible files in the **\ETHERCheck** directory will be displayed. If there are more than 1, the UP and DOWN arrows will move the highlight. Once the desired file is highlighted, press Enter.

- First, the WeldCheck+ will erase the existing software from the flash, this will take approx. 10 seconds.
- Now the new version will be installed. Its progress in percent is shown. It will take approx. 1.5 minutes.
- When instructed to Reboot, hold the power key until the screen goes BLACK, this will take approx. 10s. Now release the key.
- Installation is now complete and the instrument can be used as normal. If there was a problem during installation the WeldCheck+ may be unusable as an Eddy Current Instrument until a successful installation has occurred. If this was due to a corrupt version of the firmware on the micro Card (this is the usual cause) then a valid version will need to be copied on to the card, see removing the micro Card in 2) above.

8.2 Default Mode

In the Load Save Menu there is a DEFAULT setting that cannot be altered by the user. Use this to put the instrument into a pre-defined state.

8.3 ETherRealtime PC Package

To connect to the WeldCheck+ from a PC, the **ETherRealtime** package must be used. This package is freely available from ETherNDE and is present on the supplied USB Memory Stick, or downloadable from our Website.

ETHERRealtime PC allows remote control of the WeldCheck+ instrument, displays real-time values from the instrument and allows files (Settings, Screenshots and Software Update files) to be taken from and loaded on to the instrument micro SD Card. ***ETHERRealtime*** PC main screen:

Description of components:

1. 11-key Keypad. This is the same as the keypad on the instrument. Clicking on a key here has the same effect as pressing the real key on the instrument, with the exception of the Power Enter key.
2. ALARM indicator. If the instrument has an alarm configured this button will glow RED in sync with that of the instrument.
3. Progress Bar. If a file transfer is in progress, this bar shows the progress.
4. 5 Tabs offering different information on the connected instrument, Connection, Data Logging, File System, Phase Plane, Settings. See below for a description of each.

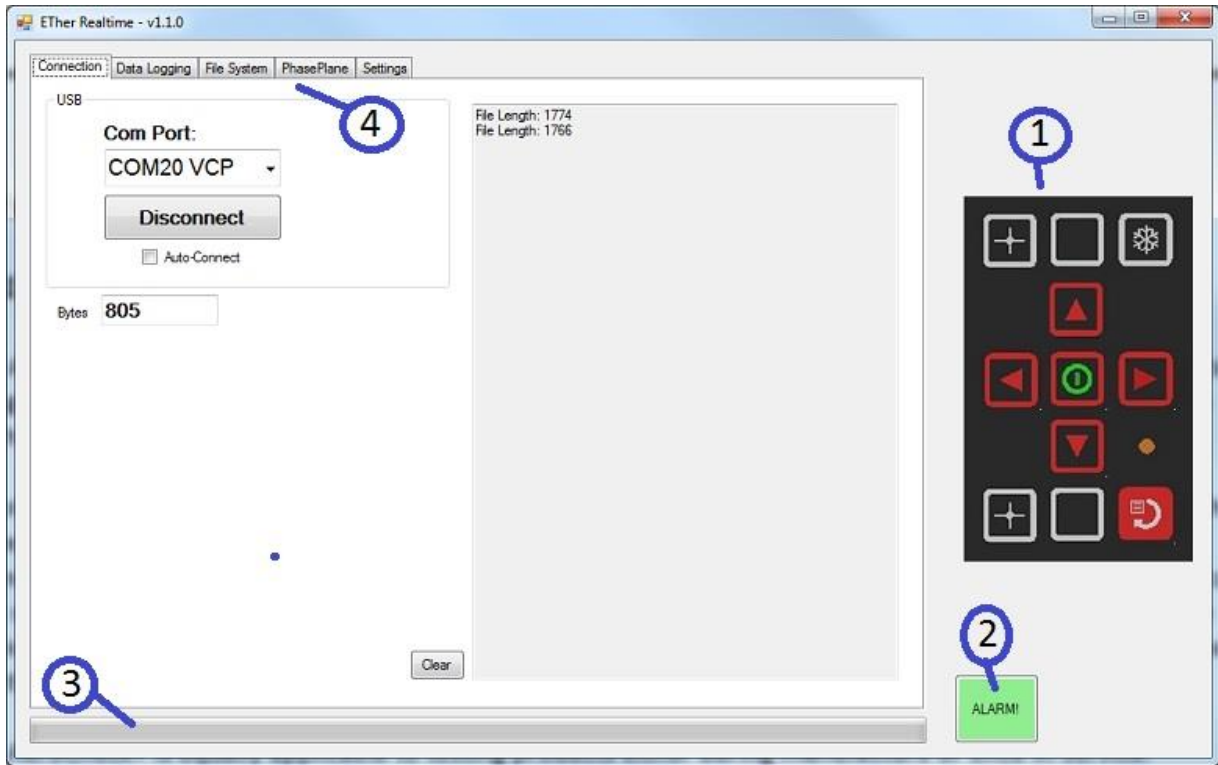

8.3.1 ETherCheck Tabs

8.3.1.1 Connection

When an WeldCheck+ is connected to the PC via USB its COM port will automatically be displayed in the drop down. Click **Connect** to connect to the instrument or check Auto-Connect to do exactly that when an instrument is plugged in.

8.3.1.2 Data Logging

The 6 radio buttons select what sort of data is to be transmitted by the instrument:

- Conductivity – Only use when the instrument is in Conductivity Mode. The Conductivity and Lift-Off are shown, along with the other technical values of Radius and Theta.
- Non-Realtime – The values of X & Y for channel 1, 2 & Mix and Radius & Theta of Channel 1 are shown. The data rate is slower and not suitable for automated systems but more than sufficient for use by a person.
- Single Channel Post – This is post-processed data that has been offset to show actual screen coordinates. This setting must be used for the Phase Plane tab to show data.
- Post Process – This shows real-time post processed data for Channels 1, 2 & Mix.
- Raw – Raw Eddy Current data from the probe for channels 1 & 2.
- None – Shows nothing.

8.3.1.3 File System

When an WeldCheck+ is connected to CheckPC and the **File System** Tab is selected **ETHerRealtime** will download the file system that is present on the micro SD card, accessible under the flap. The file system is displayed in a window. Each folder can be expanded or collapsed by clicking on the + or – symbol. An example screen shot is shown below:

Description of components:

1. This is a Folder. It can be expanded and collapsed using the + and – icon to the left of the text.
2. This is a Software update file (ends in .hex). These MUST be in the Ether Check folder to be recognised by the Boot Loader.
3. In the Saves folder are the Settings folders and files that are used by the

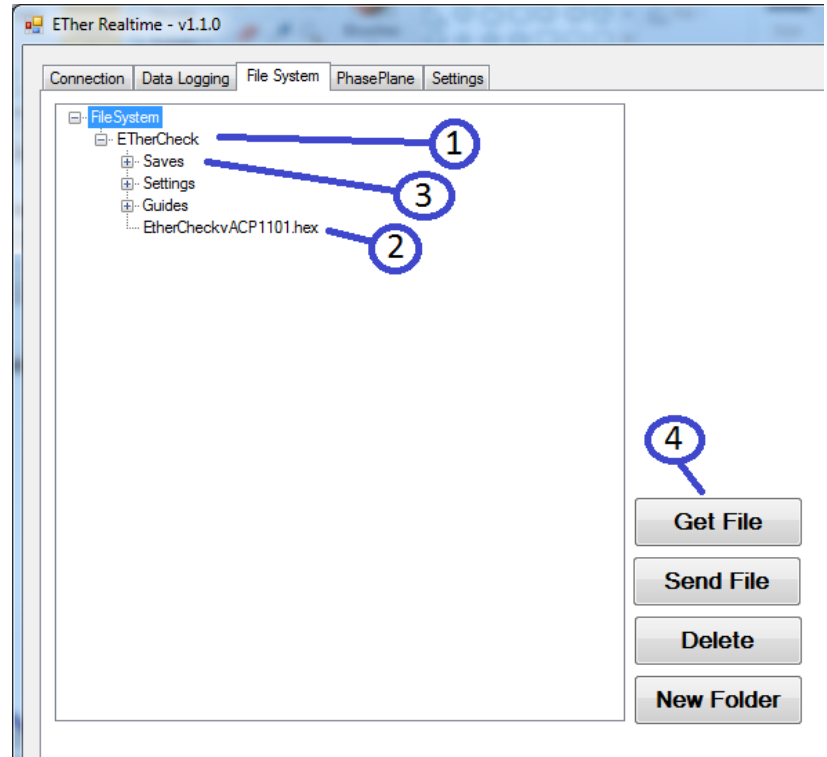

instrument. Several are present by default on a new machine. Users create others. They can be retrieved or sent to an WeldCheck+ (see below).

4. File action buttons; Delete (File or Folder), Get File, Send File and New Folder. These buttons, are only available once a file or folder is highlighted. See below for detailed explanation of there use.
 - a. Deleting a File (or Folder)

If a File or Folder is highlighted, clicking on **Delete File** will delete the specified file. BE VERY CAREFUL when doing this, deleted files cannot be undeleted afterwards. A folder MUST be empty before it can be deleted.
 - b. Get File (getting a file FROM the WeldCheck+):

Click on a file so that it is highlighted. Click on **Get File**. The file will upload to the PC; its progress will be shown on the progress bar on the main screen. Once complete, a file save dialog window will appear. Use this to choose a location and filename of the uploaded file.
 - c. Send File (Sending a file FROM the PC to the Weld Check) :

Click on a folder (or file within a folder) that will receive the file. Click on Send File. A File Open dialog window will appear, find and choose the file to send TO the WeldCheck+. Click Enter. The file will begin downloading; its progress will be shown on the progress bar on the main screen. Once complete, the File System window will refresh and the new file should be visible.
 - d. New Folder.

With an existing folder highlighted, click on this button to create a new folder within the highlighted one. A new window will appear requesting the name of the new folder to be created.

8.3.1.4 Phase Plane

This tab attempts to mimic the realtime display of the instrument. For this to work the ***Single Channel Post*** button must be selected on the previous Tab.

8.3.1.5 Settings

This displays a full set of the instruments settings that it is currently using. Please note, these values are not all human readable but are what the instrument requires should commands need to be sent by automated equipment.

9 Specification

Probe	Connectors	12 Way Lemo 2b (Absolute, Bridge and Reflection) and Connection Lemo 00 (for single element absolute probes). Simultaneous probe operation possible using Lemo 12 way and Lemo 00.
	Conductivity	Option becomes active with use of AeroCheck + conductivity probe and cable
Frequency	Dual Freq./Channel	10 Hz to 12.8 MHz
Gain	Overall	-18 to + 104 dB, 0.1, 1 and 6dB steps
	Input	0dB or 12dB
	Drive	0dB, 6dB and 10dB (0dB reference 1mW into 50 ohm)
	Max X/Y Ratio	+/-100.0 dB
Phase	Range	0.0-359.9°, 0.1° steps
Filters	High Pass	DC to 2kHz or Low Pass Filter, which ever is the lower in 1 Hz steps. Plus variable adaptive balance drift compensation 0.01 - 0.5 Hz (6 steps).
	Low Pass	1Hz to 2KHz or a quarter of the lowest test frequency whichever is lower in 1 Hz steps.
Balance Load	Manual	14 internal balance loads; 2.2μH, 5.0μH, 6.0μH, 6.5μH, 7.0μH, 7.5μH, 8.2μH, 12μH, 15μH, 18μH, 22μH, 30μH, 47μH, 82μH,
	Automatic	Optimised balance load selection.
Mix Channel	Frequency	Full frequency range available on both channels

	Probe Mode	Simultaneous reflection / bridge and absolute including simultaneous two probe Differential and Absolute
	Mix Gain	X/Y -18 to +18dB
	Mix Phase	0.0-359.9°, 0.1° steps
Alarms Gates	Box	Fully configurable, Freeze, Tone or visual.
	Sector	Fully configurable, Freeze, Tone or visual.
Display	Type	5.7" (145mm), 18 bit Colour, daylight readable.
	Viewable Area	115.2mm (Horizontal) x 86.4mm (Vertical)
	Resolution	640 x 480 pixels
	Flip	Manual or automatic screen orientation change to enable left or right handed use.
	Colour Schemes	User configurable Dark, Bright and Black & White
	Configurable Screen	Full Screen, Single, Dual Spot or Dual Pane with variable size and location and function e.g. XY, Timebase, Waterfall and Meter.
	Display Modes	Spot, Time base (0.1-20 seconds x 1-200 sweeps and up to 55 seconds), Waterfall and Meter with peak hold and % readout.
	Graticules	None, Grid (4 sizes 5, 10,15 and 20% FSH), Polar (4 sizes 5, 10,15 and 20% FSH)
	Offset	Spot Position: Y =-50 to +50, X =-65 to +65%
	Digital Spot Position Readout	Display in X,Y or R, θ
Summary	Display of all settings in Legacy Format	

Removable Data Storage	Setup Storage	microSDHC up to 32GB, holding over 10,000 settings
	Stored Screen Shots	micro SD up to 32GB, holding over 10,000 screen shots
	Recorded Data	micro SD up to 32GB, holding over 500 2.5 minute long data recordings
	Guides	micro SD up to 32GB, holding 10,000 Slides

Advanced Features	Data logging	Real-time recording of signal data and Replay on instruments and desktop PC up to 164 seconds
	Guides	Create and display a slide show containing instructions, tutorials and procedures using Microsoft PowerPoint.
	Attachments	Screenshots and Data Recordings are saved in a folder with the name of the Settings.
	Loop	Capture a live repetitive signal and then optimise the instrument settings (Phase, Gain, Filters) to simplify optimising the parameters
	Trace	Allows a calibration reference signal to be stored on the screen and then compared with the live signal
	Auto Phase	Allows phase angle to be automatically set to a pre set angle
Outputs	PC Connectivity	USB (Full PC remote control plus Real Time data)
	Digital volt free Alarm	On Lemo 12 way Open collector transistor (36v dc at 10mA max).

	VGA	Full 15 way VGA output (EC screens only)
Languages		English, French, Spanish, Russian, Japanese, Chinese, Turkish.
Verification Level		The system includes on delivery a 2 year validity Verification Level 2 detailed functional check and calibration as per ISO 15548-1:2013
Power on self test		The system performs a self-test on start up of external ram, sd ram, accelerometer, Micro SD card, and LCD screen buffer.
Power	External	100-240 v 50-60Hz 30 Watts
	Battery	Internal 7.2V nominal @ 3100mAh = 22.32 watt.hr
	Running Time	Up to 8 hours with a 2MHz Pencil Probe 30% Back Light
	Charging Time	2.5 hrs. charge time, Simultaneous charge and operation
Physical	Weight Including Internal Battery	1.3 kg, 2.9 lbs.
	Size (w x h x d)	237 x 146 x 53 mm / 9.3 x 5.7 x 2.1 inches
	Material	Aluminium alloy Mg Si 0.5 powder-coated epoxy
	Operating Temperature	-20 to +60 °C
	Storage Temp	Storage for up to 12 months -20 to +35 °C Nominal +20 °C
	IP Rating	IP54

10 System Self-Test Codes

Error	Name	Description
2	External RAM Initialisation	Configures the internal RAM IO lines.
8	SDRAM Initialisation	If SDRAM config. times out, report ERROR.
32	Memory Tests	Required memory configured and cleared.
512	Accelerometer Initialisation	Configuration over I2C. I2C Comms error returned.
1024	uSD Disk Initialisation	If disk not present or failure, error returned.
8192	LCD Screen Buffer test.	Write and read a coloured pixel. Error if different.

11 Safety and Environmental

Safety: Even classified as lithium ion batteries UN3480 or UN3481 (Contained in Equipment or Packed with Equipment), the product is handled as Non-Dangerous Goods by meeting the UN Recommendations on the Transportation of Dangerous Goods Model Regulations Special Provision SP188 and IATA Dangerous Goods Regulations Packing Instruction 965-967 General Requirement and Section II (Excepted) is applied for air transportation, IMDG Code SP188 is applied for marine transportation. Battery has passed the UN T1-T8 tests and may be shipped as excepted from these regulations. Battery MSDS sheet available on request.



EC Declaration of Conformity - this product is CE marked; CE marking signifies that the product conforms with all EU directives or EU regulations that apply to it.



Environmental Protection: This product should not be disposed of with household waste. Please recycle where facilities exist. Check with your local Authority or retailer for recycling advice.

11.1 EC Declaration of Conformity

We

ETherNDE Ltd

Of

*ETher NDE Ltd.
Endeavour House,
Unit 18, Brick Knoll Park,
Ashley Road,
St Albans,
Hertfordshire,
AL1 5UG
United Kingdom*

Hereby declare that:

Equipment: WeldCheck+ Eddy Current Flaw Detector

Model Number: IWEL002

Meet the intent of Directive 89/336/EEC for Electromagnetic Compatibility.

Compliance tested to:

Test Specification: EN 61326-1:2006
Title: Electrical equipment for measurement, control and laboratory use.

Test Specification: EN 55011:2009 + A1:2010
Title: Industrial, scientific and medical (ISM) radio frequency equipment.
- Radio disturbance characteristics

Test Specification: EN61000 Part 4
Title: Electromagnetic compatibility (EMC)
- Part 4. Testing and measurement techniques.

Sections: EN61000-4-2: 2009 - Electrostatic discharge immunity test.
EN61000-4-3: 2006+A2:2010- Radiated radio frequency electromagnetic field immunity test.