

ETHER NDE



Eddy Current Solutions

Eddy Current Instrument for Aircraft Inspection

AeroCheck3

User Manual



ETHer NDE Ltd.
Endeavour House,
Unit 18, Brick Knoll Park,
Ashley Road,
St Albans,
Hertfordshire,
AL1 5UG.

Tel: +44 (0) 1727 648050
www.ethernde.com
sales@ethernde.com

Contents

Contents	3
1 Introduction	7
1.1 About the AeroCheck3.....	7
1.2 A first look at the instrument.....	9
1.3 Keypad.....	12
1.3.1 <i>Cursor, Power/OK Keys</i>	12
1.3.2 <i>Balance, Programmable, Freeze, Gain, Phase, Menu/Back Keys & LED Indicator</i>	13
1.4 ThumbWheel.....	16
1.5 Connectors (probe and charger):.....	17
1.6 Connectors (accessory connectors under flap).....	18
2 Standard kit and recommended probe kits and accessory packages	19
2.1 Standard Kit (Keypad Only Option).....	19
2.2 Standard Kit (Keypad + Thumbwheel Option).....	20
2.3 Recommended Accessory Probe Kit Packages.....	21
2.4 Optional Accessories.....	26
3 Getting Started	27
3.1 Battery Charging.....	27
3.2 Switching the instrument on.....	27
3.3 The opening screen.....	27

3.4	Switching the Instrument Off.....	30
4	Operation	31
4.1	Operating screen.....	31
4.2	Main Menu.....	33
4.2.1	<i>Side Bar Programming Pane.....</i>	<i>34</i>
4.2.2	<i>Eddy Current Pane.....</i>	<i>35</i>
4.2.3	<i>Configure Pane.....</i>	<i>39</i>
4.2.4	<i>Display Pane.....</i>	<i>43</i>
4.2.5	<i>Advanced Pane.....</i>	<i>44</i>
5	Setting the AeroCheck3 to perform an inspection.	65
5.1	With a configuration file.....	65
5.2	With no configuration files	65
5.3	Sample application setup.....	65
5.3.1	<i>High Frequency Surface Inspection.....</i>	<i>67</i>
5.3.2	<i>Low Frequency Sub-Surface Inspection.....</i>	<i>70</i>
5.3.3	<i>Rotary Setting.....</i>	<i>72</i>
5.3.4	<i>Dual Frequency Mixing</i>	<i>74</i>
5.3.5	<i>Conductivity.....</i>	<i>79</i>
	Tips for Accurate Measurements:	86
	Specification:	86

6	Probes	87
6.1	Pencil Probes (Double Shielded) – Absolute/Bridge	87
6.1.1	<i>Straight – Absolute with plastic handle coding:</i>	90
6.1.2	<i>Straight – Bridge (IB Tech Inside) with plastic handle coding:</i>	92
6.1.3	<i>90deg Tip – Absolute with plastic handle coding:</i>	94
6.1.4	<i>90deg Tip – Bridge (IB Tech Inside) with plastic handle coding:</i>	96
6.1.5	<i>45deg Crank – Absolute with plastic handle coding:</i>	98
6.1.6	<i>45deg Crank – Bridge (IB Tech Inside) with plastic handle coding:</i>	100
6.1.7	<i>15deg Crank 90deg Tip – Absolute with plastic handle coding:</i>	102
6.1.8	<i>15deg Crank 90deg Tip – Bridge (IB Tech Inside) with plastic handle coding:</i>	104
6.2	Rotating Probes – Reflection	106
6.2.1	<i>Rigid Stainless-Steel Coding</i>	107
6.2.2	<i>Delrin Flexible Coding</i>	112
6.3	Manual Bolt Hole Probes – Absolute	114
6.4	Spot Face Low Frequency Probes	118
6.5	Sliding Probes – Dual Element	121
6.6	Low Frequency Fastener Inspection Probes	123
7	Connectors	126
8	Software Update and System Recovery	128
8.1	Updating AeroCheck3 software	128
8.2	Default Mode	129
8.3	ETHerRealtime PC Package Note: Always check with ETHerNDE for current ETHerRealtime version.	129

8.3.1	<i>ETherCheck Tabs</i>	132
8.3.2	<i>Connection</i>	132
8.3.3	<i>Data Logging</i>	132
8.3.4	<i>File System</i>	133
8.3.5	<i>Phase Plane</i>	135
8.3.6	<i>Settings</i>	135
9	Specification	136
10	System Self-Test Codes	140
11	Safety and Environmental	141
11.1	EC Declaration of Conformity	142

1 Introduction

1.1 *About the AeroCheck3*

The AeroCheck3 instrument is a dual frequency/dual channel eddy current inspection instrument with digital conductivity and rotary. It is designed for flaw detection and evaluation using the Eddy Current non-destructive testing (NDT) inspection method particularly for use (but not exclusively) in aircraft inspection.

AeroCheck3 can perform a great many eddy current inspection tasks including: surface/subsurface defect detection, adjustable high-speed rotary inspection of holes and low frequency inspection of non-ferrous material. The dual frequency/dual channel capability means that the instrument can perform, in addition to single frequency, applications that require dual frequency. Examples of dual frequency are the suppression of unwanted signals by mixing (signal subtraction) or dual test with one probe (typically simultaneous absolute and differential testing) or dual probe testing where one probe must be absolute but the other could be any selected probe type in the Probe Mode pane.

The AeroCheck3 is equally applicable to testing products either during manufacture or once in-service. It is also ideal for training institutions for basic eddy current instruction and introduction to single and dual channel tubing applications.

Due to its 10Hz-20MHz-frequency range it can detect surface and subsurface defects in components made from non-ferrous metals and their alloys and on ferrous materials can detect surface breaking defects.

Always refer to the applicable inspection and operator certification procedures and national and international standards before undertaking a test particularly those referring to certification of operators.

The instrument may be used with nearly all eddy current probes including:

- Absolute single element probes
- Absolute bridge connected probes
- Absolute reflection connected probes (e.g. Spot Absolute Probes)
- Differential bridge connected probes (e.g. ID Probes)
- Differential reflection connected probes
- Sliding transmit receive reflection probes
- Rotary drives. Directly compatible with both ETher and GE/Hocking rotary drives and by means of an adapter with Rohmann drives MR1, SR1 and SR2. Contact Ether directly with any questions on other manufacturers drives for support.

The User Manual of the ETher NDE AeroCheck3 portable eddy current instrument (referred to as the "instrument") is intended to explain the operating principles.

1.2 A first look at the instrument.

This section gives an overview of the various external features of the instrument. The AeroCheck3 series now offers the option of two models, one with the standard keypad for instrument navigation or a thumbwheel configuration (as shown below).

Fig. 1 – AeroCheck3
Front Panel

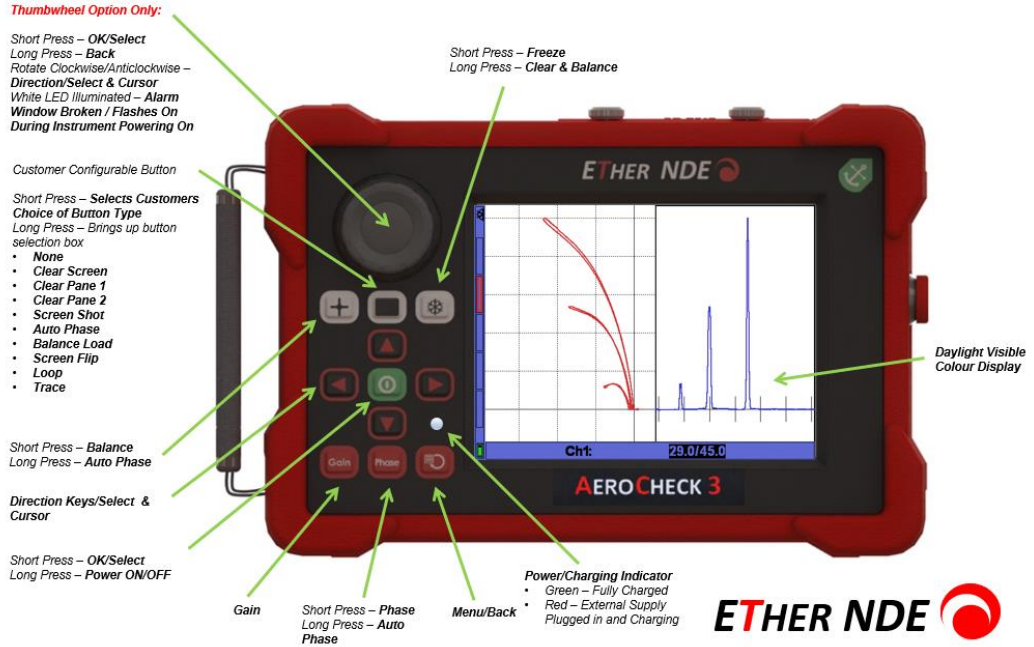

Fig. 2 – AeroCheck3 Overview



Pressing the MENU/BACK key



toggles between the Main Menu and Operating screen.

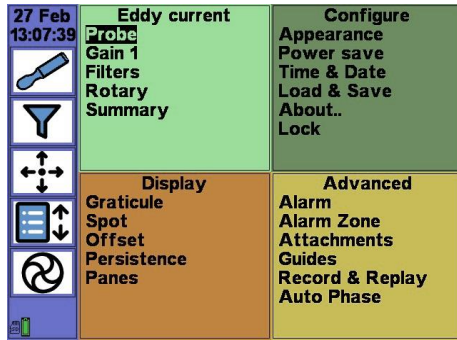

Main Menu

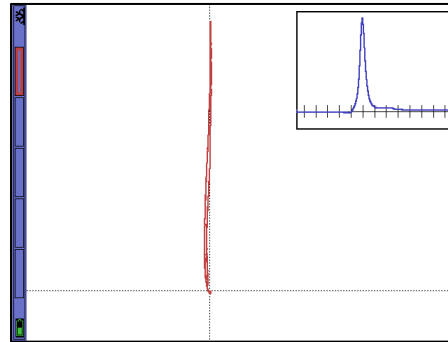

Operating Screen

Pressing the LEFT & RIGHT cursor keys on the operating screen allows you to change the side bar on the left between Small, Quick-Menu, CH1 and if dual frequency mode CH2 and Mix.

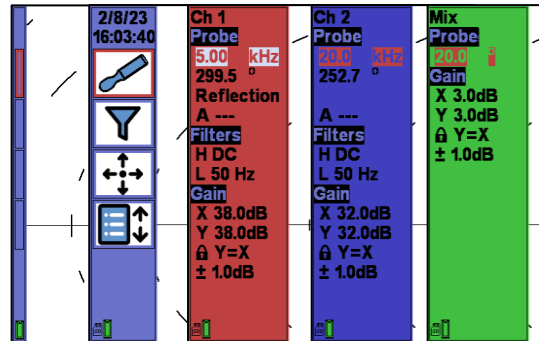

Side Bar Options

1.3 Keypad

1.3.1 Cursor, Power/OK Keys

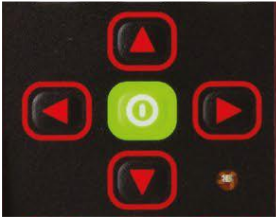

Long press (greater than 3 seconds) on the centre/enter key switches the instrument on.

The 4 red arrow keys are cursor keys and the centre key acts as the enter key.

In the operating screen pressing the right cursor key changes the side bar from the default setting of the user programmable quick access icons to the quick setting menu for channel 1, 2 or mix. Press the left cursor key to exit the quick-menu display.

In the operating screen pressing the left cursor key changes the side bar from the default setting to a smaller version, this allows a full screen view of the Main Pane. Press the right cursor key to expand the menu once again.

In the menu screens the direction keys move the cursor/selection point Left, Right, Up, Down. The centre key is used first to select a menu item. Once a menu item is selected its various values can be highlighted using the UP and DOWN keys. Pressing OK will then allow the individual highlighted value to be modified. Pressing Enter again will accept the value and return to having the sub menu highlighted. Press the Back Key to accept all values and return to the Main Menu.

Long press (greater than 3 seconds) on the centre/entre key switches the instrument off if a setting has been changed the operator will be prompted to save the current setting or not.

1.3.2 Balance, Programmable, Freeze, Gain, Phase, Menu/Back Keys & LED Indicator



Eddy current signal balance. Long Press (greater than 3 seconds) activates Auto Phase (see 5.2.5.6).



Independent User programmable blank soft keys, a 3 second press on either of these will show a list of the programmable options. Up Down to select and centre key to Enter. Once programmed use a short press to activate key function. Functions selectable from;

- None
- Clear Screen – clear whole screen
- Clear Pane 1 – clear only pane 1
- Clear Pane 2 – clear only pane 2
- Screen Shot – saves a bitmap of the current screen display. Note: Screen Shots are saved to the SD card and appear in a set-up folder along with the currently selected settings.
- Auto Phase – Activates the Auto Phase setting function.
- Balance Load – in absolute mode automatically optimises the balance load using one of the internal loads.
- Screen Flip – toggles the screen orientation from right-handed to left-handed.

- Loop – records a short section (equal to persistence time) of data and displays it repetitively. This allows easy setting of gain, phase, filters, display, and other parameters. Toggles on and off on key presses.
- Trace – Stores the current displayed trace in Pane 1 to the Graticule layer of the image. 2nd press erases this trace from the graticule layer. Good for making comparative tests. Toggles on and off on key presses.

Programmed key settings are saved in a setting file so each setting can have the most useful function programmed.



Press to Freeze Display second press toggles/Long press to erase.



Press to gain quick access to bottom gain bar, press again to hide bottom bar.

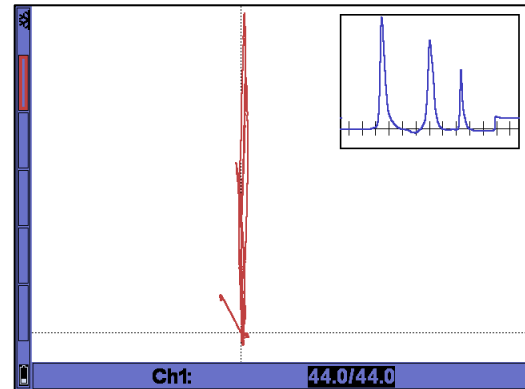



Press to gain quick access to bottom Phase bar, press again to hide bottom bar.

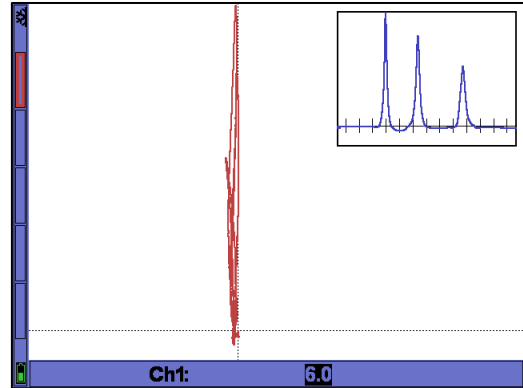

The menu/back key gives quick access to the main Menu as well as going back to the previous item.



LED indicator –

Green – Fully Charged

Red – External Supply Plugged in and Charging

27 Feb 13:07:39 	Eddy current Probe Gain 1 Filters Rotary Summary	Configure Appearance Power save Time & Date Load & Save About.. Lock
	Display Graticule Spot Offset Persistence Panes	Advanced Alarm Alarm Zone Attachments Guides Record & Replay Auto Phase

1.4 ThumbWheel

Only available on AeroCheck3 instrument IWEL300TW:

Short Press – OK/Select

Long Press – Back

*Rotate Clockwise/Anticlockwise –
Direction/Select & Cursor*

White LED Illuminated – Alarm

**Window Broken / Flashes On During
Instrument Powering On**

Please note that the Alarm Action must be set to flash for the LED to illuminate.

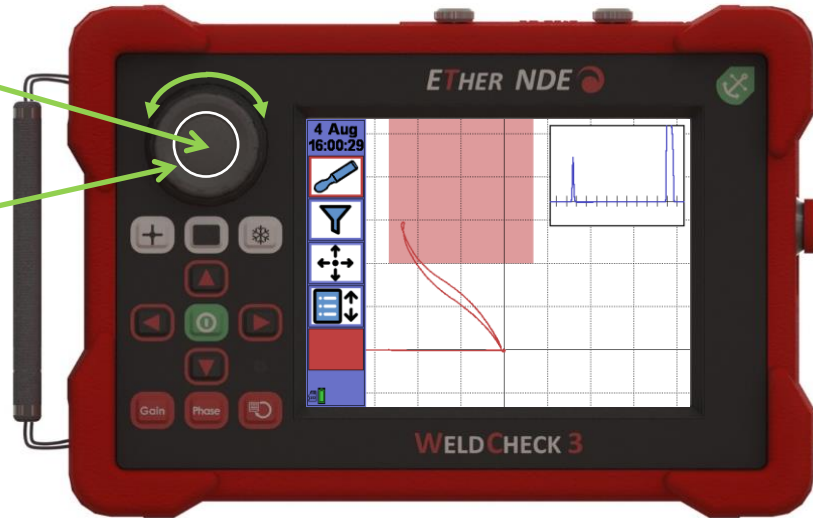

1.5 Connectors (probe and charger):

Absolute Probes
Bridge Probes
Reflection Probes
ETHER Conductivity
Probe
Lemo 12-Way

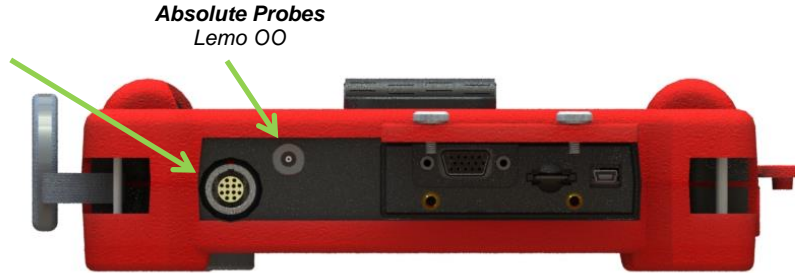

Absolute Probes
Lemo 00



Probe Connectors – There are two different probe connectors.

- a) **Coaxial Connector** - (Lemo 00) to connect absolute probes. This connector is selected in the Menu Eddy Current /Probe Function as Absolute-00. To use our standard microdot absolute probes then use part number ALLCX-M02-015A and for BNC absolute probes use part number ALLCX-B02-015A. To connect Absolute probes with a cable terminated with a BNC connector at the instrument end then use adapter part number AALCX-B02S.
- b) **Probe Connector** - (Lemo 12-Way) connects Bridge, Reflection, Absolute probes, and Rotary Drives. For Bridge probes using a 4 pin Lemo connector (e.g. disconnect weld probes) use part number ALL12-L04-015B. For Reflection probes (e.g. spot faced probes such as PUS13) use ALL12-L04-015R. By using adapter part number AAL12P-B02S then absolute probe with cables terminated with a BNC connector may be connected.
- c) **Power** – (Lemo 2-Way) only use the factory supplied charger/power supply.

1.6 Connectors (accessory connectors under flap)

Open the flap by unscrewing the x2 thumb screws.

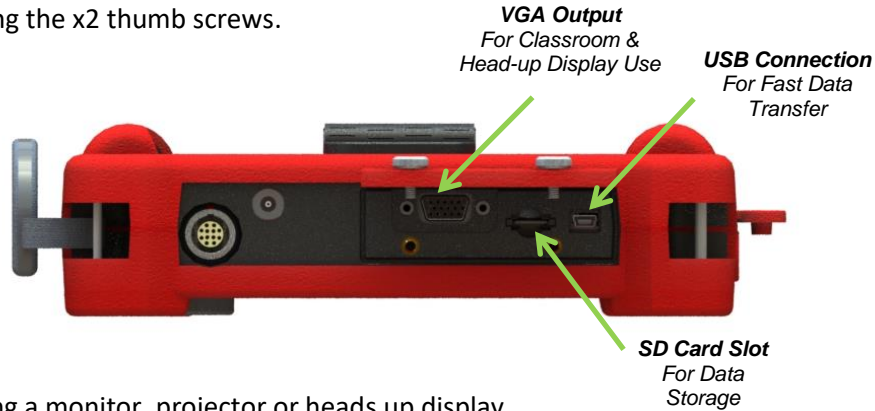

VGA - for video output using a monitor, projector or heads up display.

Micro SDHC Card - can add up to 32GB of removable memory.

USB - used to connect to a PC for data transfer and remote operation

2 Standard kit and recommended probe kits and accessory packages

2.1 Standard Kit (*Keypad Only Option*)

KIT, AeroCheck3, Eddy Current Portable Flaw Detector, Dual Frequency.

Including:

	KIAER300	
AeroCheck3 Instrument including USB Stick with manual	IAER300	1
Accessory, AeroCheck3, Power Adapter + Input Plugs (UK, EU, US & Australia)	AWEL009	1
Accessory, Adjustable Padded Shoulder Strap Quick-Release Clips	AWEL003	1
Accessory, Instrument Soft Carry Case, (AeroCheck3)	AC006	1
USB CABLE - A to MINI B, 1m	A090	1
Quick Reference Card – AeroCheck3	41292	1
Accessory, Lead, Lemo 00 to Microdot, 1.5m	ALLCX-M02-015A	1
Accessory, Lead, Lemo 12-Way - Lemo 4-Way, 1.5m (Reflection)	ALL12-L04-015R	1
Stainless Steel Clevis Split Rings - Made from 316 Marine Grade Stainless Steel	A439	4

For Bridge probes lead ALL12-L04-015B is required.

2.2 Standard Kit *(Keypad + Thumbwheel Option)*

KIT, AeroCheck3, With Thumbwheel, Eddy Current Portable Flaw Detector, Dual Frequency. Including:

KIAER300TW

AeroCheck3 Instrument including USB Stick with manual	IAER300TW	1
Accessory, AeroCheck3, Power Adapter + Input Plugs (UK, EU, US & Australia)	AWEL009	1
Accessory, Adjustable Padded Shoulder Strap Quick-Release Clips	AWEL003	1
Accessory, Instrument Soft Carry Case, (AeroCheck3)	AC006	1
USB CABLE - A to MINI B, 1m	A090	1
Quick Reference Card – AeroCheck3	41292	1
Accessory, Lead, Lemo 00 to Microdot, 1.5m	ALLCX-M02-015A	1
Accessory, Lead, Lemo 12-Way - Lemo 4-Way, 1.5m (Reflection)	ALL12-L04-015R	1
Stainless Steel Clevis Split Rings - Made from 316 Marine Grade Stainless Steel	A439	4

For Bridge probes lead ALL12-L04-015B is required.

2.3 Recommended Accessory Probe Kit Packages

KIT, Surface Inspection. Including:

KASUR001

Probe, Unshielded, 500kHz, Fe/NFe, Plastic Handle, Straight, 100mm Long	PU500PSFE/NFE	1
Probe, Shielded, 2MHz, Plastic Handle, Straight, 28mm Tip Length (Total Length 114mm, 4.5") (Straight Shank)	PS002PS028-114N	1
Probe, Shielded, 2MHz, Plastic Handle, Straight, 28mm Tip Length (Total Length 114mm, 4.5") (Straight Shank)	PS500PD064-114N	1
Probe, Shielded, 2MHz, Plastic Handle, Double Crank, 6.4 (0.25") Tip Length (Total Length 114mm, 4.5") (15deg Crank, 90deg tip Shank)	PS002PD064-114N	1
Probe, Knife, 65 deg, 2MHz, NFe, Unshielded	PK065002NFE	1
Cable Lemo 00 Coaxial to Microdot Plug Absolute cable 1.5m	ALLCX-M02-015A	1
Test Block, Ferrous (Steel EN1A), 0.2, 0.5, 1.0mm slots	ATBF	1
Accessory. Test Block, Ferrous (Steel EN1A), 0.2, 0.5, 1.0mm slots	ATBA	1
Accessory, Butterfly PTFE Tape (Pack of 30)	AW003	1
Accessory, Deluxe Probe Case	AC002	1

KIT, Rotary Drive Inspection. Including:

KAROT001

Accessory, Rotating Drive, Small, Lemo 12-Way (MERCURY)	ARD002	1
Accessory, Lead, Lemo 12-Way - Lemo 12-Way, 2.0m (Rotating Drive)	ALL12-L12-020M	1
Accessory, Deluxe Probe Case PHDC1	AC002	1

KIT, Rotary Drive Inspection - x6 Rigid Probes (4.76mm to 12.70mm) + Multi-Hole Test block 3/16" to 1/2" (4.76 to 12.70mm). Including:

KAROT002

Accessory, Rotating Drive, Small, Lemo 12-Way (MERCURY)	ARD002	1
Probe. Rotating, Rigid, Dia = 4.76mm (3/16"), wl = 35mm	PRR0476-035	1
Probe. Rotating, Rigid, Dia = 6.35mm (1/4"), wl = 35mm	PRR0635-035	1
Probe. Rotating, Rigid, Dia = 7.94mm (5/16"), wl = 35mm	PRR0794-035	1
Probe. Rotating, Rigid, Dia = 9.53mm (3/8"), wl = 35mm	PRR0953-035	1
Probe. Rotating, Rigid, Dia = 11.11mm (7/16"), wl = 35mm	PRR1111-035	1
Probe. Rotating, Rigid, Dia = 12.70mm (1/2"), wl = 35mm	PRR1270-035	1
Accessory, Test Block, Rotating probe, Total, 12 holes; Holes 3/16", 1/4", 5/16", 3/8", 7/16", 1/2", 6 sound holes and 6 holes with 0.7mm dia. side drilled holes	ATB005	1
Accessory, Deluxe Probe Case PHDC1	AC002	1

KIT, Rotary Drive Inspection – x7 Flexible (4.7mm to 12.70mm) Probes + Multi-Hole Test block 3/16" to 1/2" (4.76 to 12.70mm). Including:

KAROT010

Probe. Rotating, Flexible, Dia = 4.7 - 5.7mm, wl = 51.00mm	PRF047-057051	1
Probe. Rotating, Flexible, Dia = 4.7 - 5.7mm, wl = 51.00mm	PRF056-066051	1
Probe. Rotating, Flexible, Dia = 6.0 - 7.0mm, wl = 51.00mm	PRF060-070051	1
Probe, Rotating, Flexible, Dia = 7.0 - 8.0mm, wl=51.00mm	PRF070-080051	1
Probe. Rotating, Flexible, Dia = 8.0 - 9.5mm, wl = 51.00mm	PRF080-095051	1
Probe. Rotating, Flexible, Dia = 9.5 - 11.0mm, wl = 51.00mm	PRF095-110051	1
Probe. Rotating, Flexible, Dia = 11.0 - 12.7mm, wl = 51.00mm	PRF110-127051	1
Accessory, Test Block, Rotating probe, Total, 12 holes; Holes 3/16", 1/4", 5/16", 3/8", 7/16", 1/2", 6 sound holes and 6 holes with 0.7mm dia. side drilled holes	ATB005	1
Accessory, Deluxe Probe Case	AC002	1

KIT, Sub-surface Inspection Low Frequency. Including:

KASUBS001

1

Probe, Surface, Straight, Dia 16mm, 300Hz - 100KHz, Plastic, Lemo 4-Way	PUS16	1
Probe, Surface, Right Angled, Dia 11mm, 300Hz - 100KHz, Plastic, Lemo 4-Way	PUR11	1
Accessory, Lead, Lemo 12-Way - Lemo 4-Way, 1.5m (Reflection)	ALL12-L04-015R	1
Accessory, Test Block, Aluminium 7075-T6, 1.6mm Thick, x4 Flat Bottom Holes 75%(1.2mm), 50%(0.8mm), 25%(0.4mm), 12.5%(0.2mm) Deep.	ATB001	1

KIT, Tube Inspection Probes including the following accessories:

KATUB001

Probe, Internal Diameter, Differential, Dia 13.80mm, Disconnect, 18kHz.	PID138D0018K	1
Accessory, ID Lead, 12-Way Lemo, Flexible, 3.0m	CIDL03F	1
Accessory, Test Block, Tube, Brass, OD 5/8", (15.87mm) x 20swg, Calibration Tube	ATBTB1587	1
Accessory, Test Block, ID Probe Support Ring, OD 25.4 x ID 16.6 x 20.00mm Long	ATB010	1

KIT, Conductivity Inspection - 60kHz - Std Dia 13mm Probe (AeroCheck3)**Including:**

KACON001

Probe, Conductivity, 60kHz, Dia 13.00mm, Straight, Lemo 7-Way	PCON001	1
Accessory, Lead, 12-Way Lemo to 7-Way Lemo, 1.2m, Conductivity, (To fit AeroCheck Plus Conductivity Probe)	ALL12-L07-012-CON	1
Accessory, Dual Conductivity Reference Standards, Nominal Value 9.4% IACS (Nickel Silver) & Nominal Value 58.8% IACS, (Aluminium Alloy), (Recommended for Aluminium Alloy use)	ASIG014	1
SKIRT - Conductivity Probe (AeroCheck Plus)	40516	1
SCREW - M3 THUMB SCREW SLOTTED HEAD x 10LG PLASTIC	B3061S	1
REFERENCE HOLDER - Dual Conductivity Standard, (Thermal Bridge for Stability)	40517	1
Quick Reference Card - Guide to using Conductivity, Probe PCON001	APCON001	1
Accessory, Deluxe Probe Case PHDC1	AC002	1

KIT, Weld, Probes + Accessories. Including:

KAWEL001

Probe, Weld, Dia 16.00mm (Medium) 100kHz, , Straight, Disconnect	PWM100S000	1
Probe, Unshielded, Broad Band, 100k, (35kHz-250kHz), BNC	PUB100K	1
Accessory. Test Block, Weld Probe, Ferrous, (Steel EN1A) + x4 0.5mm Shims, 0.5, 1.0, 2.0mm slots	ATBW	1
Accessory, Lead, Lemo 12-Way - Lemo 4-Way, 1.5m (Bridge)	ALL12-L04-015B	1
Accessory, Lead, Lemo 00 to BNC, 1.5m	ALLCX-B02-015A	1
Accessory, Butterfly PTFE Tape (Pack of 30)	AW003	1
Accessory, Deluxe Probe Case PHDC1	AC002	1

2.4 *Optional Accessories*

Accessory, Protective Splash Proof Cover (For AeroCheck3 - Keypad Only – IAER300)	AWEL010	1
Accessory, Protective Splash Proof Cover (For AeroCheck3 – Thumbwheel Only – IAER300TW)	AWEL011	1
Accessory, Lead, Lemo 00 to Microdot, 1.5m	ALLCX-M02-015A	1
Accessory, Lead, Lemo 12-Way - BNC Plug, 1.5m (Absolute)	ALL12-B02-015A	1
Accessory, Lead, Lemo 12-Way - Lemo 4-Way, 1.5m (Bridge)	ALL12-L04-015B	1
Accessory, Lead, Lemo 12-Way - Lemo 4-Way, 1.5m(Reflection)	ALL12-L04-015R	1
Accessory, Lead, Lemo 12-Way to x2 Micro Plug, 1.5m (RX TX) (Reflection)	ALL12-M02-M02-015AR	1
Accessory, Lead, Lemo 12-Way - Lemo 12-Way, 2.0m (Rotating Drive)	ALL12-L12-020M	1
Accessory, PELIE STORM iM2300 Case with custom foam inserts	AWEL012	1
Accessory, Adapter Lemo 00 Coaxial to BNC Socket	AALCX-B02S	1
Hand Strap, AeroCheck3	A418	1

3 Getting Started

3.1 Battery Charging

1. Connect the instrument's AC/DC supply to the Lemo power socket. When DC power is connected, the red LED will stay on until the unit is charged then the LED will go Green. NOTE: DO NOT CONNECT ANY AC/DC POWER PACK other than those supplied by ETHER NDE otherwise the warranty will be void and irreparable damage will occur to the instrument. Options are AWEL009 (AC Charger)
2. As soon as the DC power is connected, the battery will start to be charged. With the instrument powered down the battery will charge fully within 2 hours.
3. During charging the front panel LED is Red, when charging is complete the LED colour changes to Green. If the instrument is powered up and used during charging the battery will charge more slowly than if the unit was not powered up.
4. Note the instrument may be used whilst charging is taking place.

3.2 Switching the instrument on

1. Press the POWER key until the display turns on (should be within 3 seconds).
2. The instrument will first display the product splash screen for 3 seconds.

3.3 The opening screen

The first screen the user will see once the equipment is powered up is the splash screen. Following the splash screen one of two screens will be displayed.

- 1) If favourites have been set, then a Welcome Screen is displayed.

Previous Settings – instrument will return to the settings used last time the equipment powered down

Load Favourite – select from one of the favourites on the right of the screen

Load & Save – short cut directly to the Load & Save Menu

Guide – the instrument can display guides. This item will only appear if a favourite selected in the right pane has a guide associated with it e.g. along with the Default Favourite there is an associated Guide called AeroCheck3, which is a quick guide to operating the instrument.

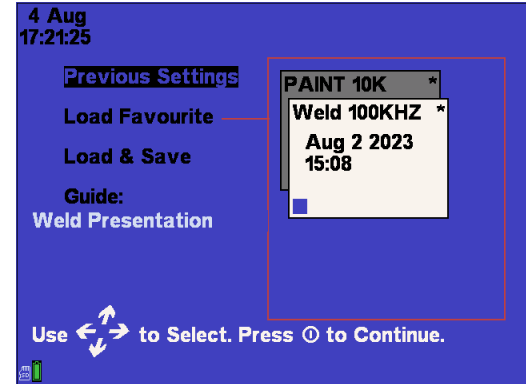

- 2) Otherwise, the operating screen is shown. On the left on the side bar are 4 icons that are user programmable soft keys, plus the lower Icon is the last function used by the user from the Main Menu or the alarm if the alarm is set active.

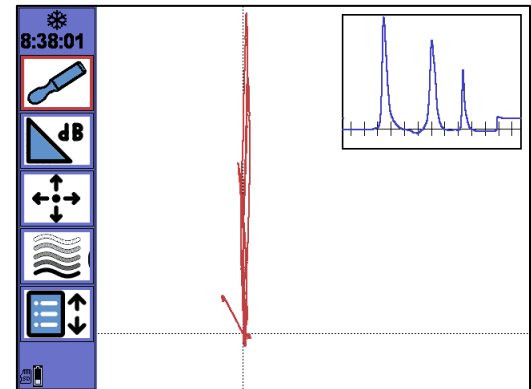

- 3) In the Operating screen pressing the right cursor key reveals the Quick Menu on the side bar. The Quick Menu provides a convenient, quick and simple way to make adjustments during a test. Use up down cursor keys to change the item selected and then press enter to adjust and up/down cursor keys now adjusts the parameter and enter.

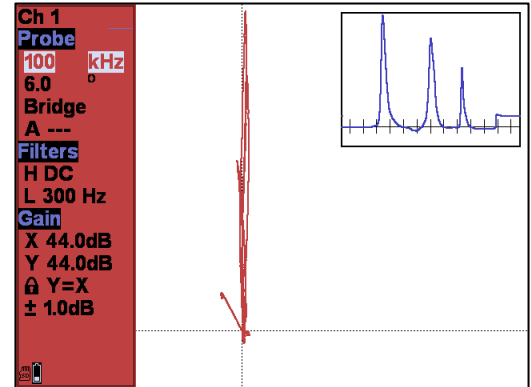





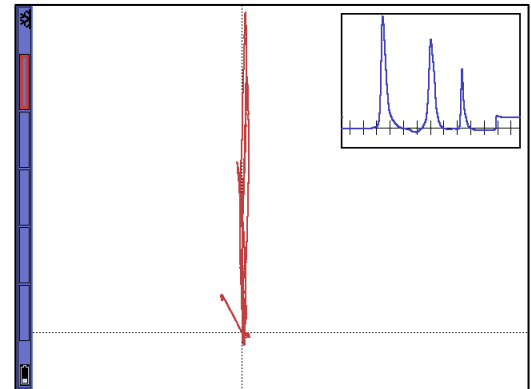

- 4) One left press then returns to the Icon Side Bar.

- 5) A further Left cursor press shrinks the side bar as shown to the right. In this mode, all menu items are still usable. A further Right cursor press reveals the Icon Side Bar Again.



6) Pressing then Menu/Back Key reveals the main menu. Pressing the Menu/Back Key then returns to the Real Time display.

27 Feb 13:07:39      	Eddy current Probe Gain 1 Filters Rotary Summary	Configure Appearance Power save Time & Date Load & Save About.. Lock
	Display Graticule Spot Offset Persistence Panels	Advanced Alarm Alarm Zone Attachments Guides Record & Replay Auto Phase

3.4 Switching the Instrument Off

Press the On/Off Enter key in the centre of the cursor keys for 3 seconds and release.

4 Operation

Once the Instrument has powered up then the Operating screen is displayed if no favourites are selected (otherwise see 3.3).

4.1 Operating screen

The Operating screen has to the left a Side Bar.

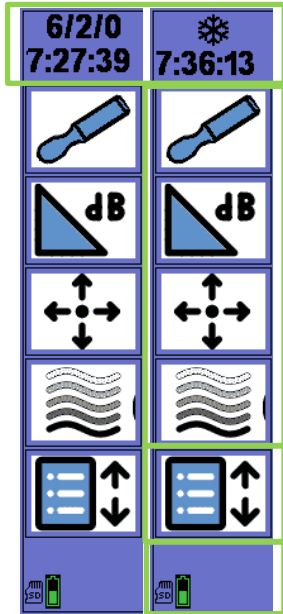

Usually, the Date and Time will be visible here, if there is a Snowflake icon at the top of the Side Bar it indicates the display is frozen (note a frozen display will not show live data). To unfreeze a short press on the freeze button and a long press clears the screen.

The top four icons are user programmable. See 5.2.1 for how to programme these icons.

The Fifth Icon slot is automatically the last item used on the Menu if it is not already programmed as an Icon unless the alarm is in use.

SD card present Icon, Battery Level (or a lightning icon indicates that external power is present) and a Spinning Replay Icon shows that a replayed signal is being displayed.

Select an Icon and then press the Enter Key to display to display a summary menu at the bottom of the screen. Use the right left key to highlight an item and Cursor Up/Down to increase and decrease the item. Press the Menu/Back Key to exit the summary menu.

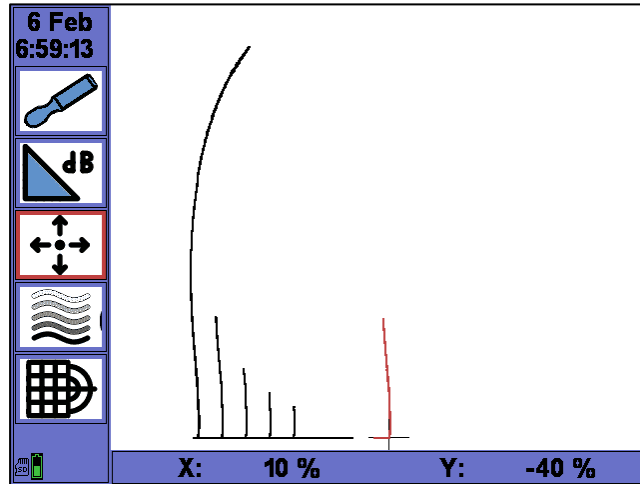

Offset Example

4.2 Main Menu

Press the Menu/Back Key to reveal the Main Menu. Depending on operation mode the screen may look different;

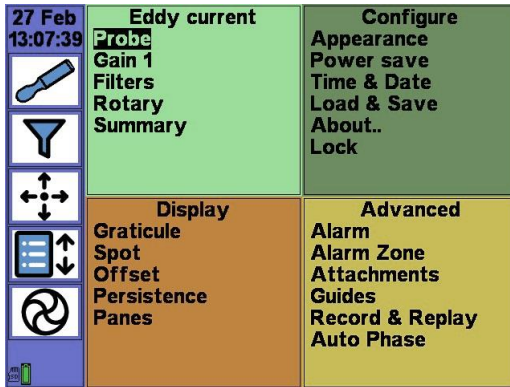

Single Channel

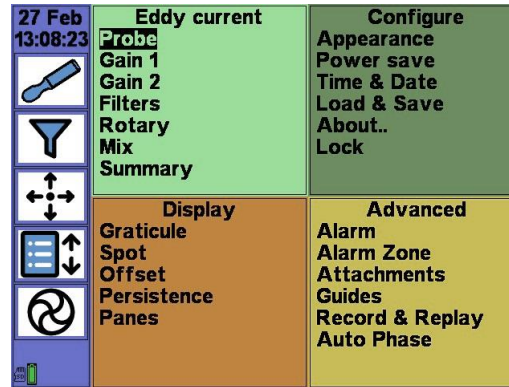

Dual Channel

The Menu is divided into several panes for ease of use. The Right/Left Cursor Keys select the pane and the up/down cursor key select individual items. Then press the Enter Key to select and the Menu/Back to leave the item. Then press the Enter Key to adjust the parameter and the Enter to leave the parameter. Pressing the Menu/Back key again to return the user to the Operating screen.

4.2.1 Side Bar Programming Pane

Programming of the Side Bar icons is done in the Menu Screen. To remove one of the top 4 icons, select the unneeded icon and perform a long press (3 seconds) on the Back/Menu Key.

To add a Menu Item, there needs to be an empty icon slot, select the item on the Menu and then perform a long press (3 seconds) on the Back/Menu Key.

The 5th slot is always the last Menu Item that was viewed, assuming that this is not already one of the top 4 or the alarm is activated.

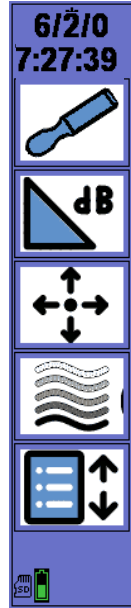

4.2.2 Eddy Current Pane

Parameters that can be adjusted are;

4.2.2.1 Probe

- Mode = Single or Dual by using the Up/Down Arrows
 - Freq 1: Channel 1 frequency adjustable from 20Hz-20MHz.
 - Phase 1: Channel 1 phase adjustable from 0.0-359.9 degrees with 0.1 degree precision
 - Freq 2: Channel 2 frequency adjustable from 20Hz-20MHz. *
 - Phase 2: Channel 2 phase adjustable from 0.0-359.9 degrees with 0.1 degree precision*
- * = only visible if Mode set to dual.
- Type: Sets how the probe is connected. Selectable from
 - a. Absolute-12= Absolute single element probe using 12-way Lemo Connector
 - b. Absolute-00 = Absolute single element probe using Lemo 00 coaxial Connector
 - c. Bridge = Bridge probes using 12-way Lemo Connector
 - d. Reflection = Reflection (Transmit-Receive or Transformer) probes using 12-way Lemo Connector
 - e. Abs1/Diff2 = Dual Probe mode with Lemo 00 for Absolute on Channel 1 and Differential/Bridge on the Lemo 12 way on Channel 2
 - f. Abs1/Ref12 = Dual Probe mode with Lemo 00 for Absolute on Channel 1 and Reflection on the Lemo 12 way on Channel 2
 - g. Abs&Diff IntL = simultaneous Dual Differential and Absolute mode on the same probe using an internal balance load.
 - h. Abs&Diff ExtL = simultaneous Dual Differential and Absolute mode on the same probe using an external balance load connected to the Lemo 00 connector. Must match the probe type and cable used.

Probe	
Mode:	Single Probe Single Freq
Freq	Probe 1 500 kHz
Phase	351.0 °
Type Load	Absolute-00 Auto 47 µH

- **Load:** Used to match single element absolute probes. Settable from Auto and from 2.2uH-82uH in 15 increments. To use the Auto Load selection feature; Select the Probe Menu Item Load and then change the value to Auto. Then set one of the Soft keys (long press) to Balance Load. With the probe required connected and preferably in contact with the test surface then Press the assigned key momentarily to perform Auto Balance Load selection.

4.2.2.2 Gain 1

Channel 1 gain parameters;

- **Gain X:** Horizontal gain in dB -18 to + 82 dB Range Settable to 0.1dB resolution.
- **Gain Y:** Vertical gain in dB -18 to + 82 dB Range Settable to 0.1dB resolution.
- **Gain Lock:** which may be set off (X and Y Gain are individually adjustable), Y=X; both gain values are equal and Fixed: where the dB ratio between the X/Y values is kept a constant difference (and hence the X/Y signal ratio remains constant).
- **Increment:** Sets the gain adjustment precision to either 0.1, 1 or 6dB
- **Drive:** Set the drive level at -6, -5, -4, -3, -2, -1, 0, 1, 2, 3, 4, 5, 6, 7, 8, 9 ,10dB
- **Input Gain:** sets the input Gain 0 or 12 dB

Gain 1	
Gain X:	82.0 dB
Gain Y:	82.0 dB
Gain Lock:	Y=X
Increment:	1.0 dB
Drive:	6 dB
Input gain:	0 dB

4.2.2.3 Gain 2

Channel 2 gain parameters;

- **Gain X:** Horizontal gain in dB -18 to + 82 dB Range Settable to 0.1dB resolution.
- **Gain Y:** Vertical gain in dB -18 to + 82 dB Range Settable to 0.1dB resolution.
- **Gain Lock:** which may be set of (X and Y Gain are individually adjustable), Y=X; both gain values are equal and Fixed: where the dB ratio between the X/Y values is kept a constant difference (and hence the X/Y signal ratio remains constant).

- Increment: Sets the adjustment precision to either 0.1, 1 or 6dB
- Drive: Set the drive level at -6, -5, -4, -3, -2, -1, 0, 1, 2, 3, 4, 5, 6, 7, 8, 9 ,10dB
- Input Gain: sets the input Gain 0 or 12 dB

4.2.2.4 Filters

- High Pass: Settable from DC= Off, 6 slow balance drift compensation filters from 0.01 Hz to 0.5 Hz and then conventional filters from 1 -2000Hz. Used to reduce unwanted low frequency signals.
- Low Pass Filter: Settable from 5-2000Hz. Used to reduce unwanted high frequency noise. Default value for manual inspection is 300Hz.
- Filter Lock: Off = both filters may be adjusted separately and Ratio: where the filters stay a fixed ratio apart.
- Increment: Sets the precision of the adjustment adjustable from 0.10 to 100.

Filters	
High Pass:	DC
Low Pass:	300
Filter Lock:	Off
Increment:	10

4.2.2.5 Rotary

Sets the required rotation speed for the drive.

- RPM: may be set from 600 – 3000 rpm in 100 rpm increments for ETHER NDE Drive.
- Rotary: Set to match drive type. ETHERNDE will operate ETHERNDE, Hocking/GE 33A100 with no adapter. Zetec and Rohman drives can be selected but require these ETHER Adaptor cables, Zetec (ALL12-L08-020M) and Rohmann MR3, SR1 & SR2 Only (ALL12-F08-020METH). For the non-ETHER drives the drive speed is expressed in %.

Rotary	
RPM	1800
Rotary Probe Type	ETHERNDE

4.2.2.6 Summary

This item shows a single screen view of all the instruments current settings, **it is fully editable**, using the arrow keys or thumbwheel highlight the setting that you would like to change, press the green OK key or thumbwheel button to enter, change settings using arrow keys or thumbwheel, press the green OK key or thumbwheel button to exit.

- Ch1 -		Summary		- Alarm -		- Probe -	
Freq	500 kHz	Source	Ch1	Drive: 1	6		
Phase	351.0°	Action		Mode:			
Gain X	82.0 dB	Stretch	5 s	Single Probe	Single Fre		
Gain Y	82.0 dB	Type	Box	Type 1	Absolute-00		
Gain Lock:	Y=X	Top	80%	Load	Auto		
Input gain:	0 dB	Bottom	30%	- Panes -			
High Pass	DC	Left	-40%	Pane	XY		
Low Pass	300	Right	10%	Source	Ch 1		
		- Offset -		Source	None		
		P1 X	0 %	Source	Time		
		P1 Y	-30 %	Source	Ch 1		
		P2 X	0 %				
		P2 Y	-25 %				

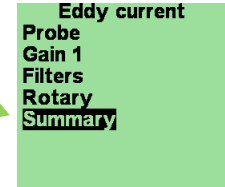

You can add the summary icon slot to the side bar for quick access (see section 4.2.1 for more details)

4.2.3 Configure Pane

4.2.3.1 Appearance

- Backlight: 10-100% lower backlight setting gives substantially longer battery life.
- Scheme: Bright = Good for outdoor use, Dark=Good for indoor use and Black & White
- Font: Bold or Italic Text
- Language: Selectable from English, French, Spanish, Italian, Portuguese, Russian, Japanese, Chinese, Turkish, Czech, and Norwegian.

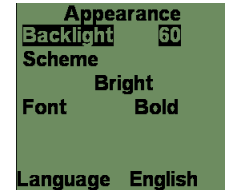

4.2.3.2 Power Save

- Auto Power Off: Off, 5-60 mins.
- Auto Screen Dim: Off, 5-60 mins



4.2.3.3 Time and Date

- Time/Date- adjust as per other parameters
- Format- Allows selection of date format from DD/MM/YY, MM/DD/YY or DD/MM



4.2.3.4 Load & Save.

Select this function by highlighting the item and pressing enter.

The main screen shows the saved settings (each blue square represents a save attachment). Use the up down cursor keys to change which saved setting is highlighted (red box) and press Enter to see a brief summary of the settings and Enter a second time to Load.

The functions of the icons are as follows;

Recall from memory →

Rename setting slot →

Save current settings to memory slot →

Delete current settings slot →

Make current Settings slot a favourite. Up to five settings may be set as favourites. →

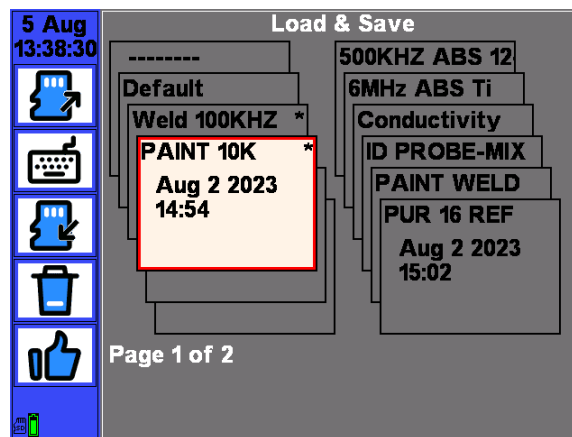

To create a new setting select the empty setting (with no name) and press enter.

A setting that has been selected as a favourite has an asterisk (*) in the top right-hand corner. Favourite settings will appear on the opening screen and provide a convenient way of quickly using the most used settings.

If no favourites are set then the instrument when powered up will start up in the Operating screen and use the last settings used.

The blue squares on the Setting Item indicate that there are screen shots associated with this setting. Red squares indicate that there are data recordings.

4.2.3.5 About

Important information about the instrument, including:

- Firmware Version
- Current Slot
- Manufactured Date
- Instrument ID

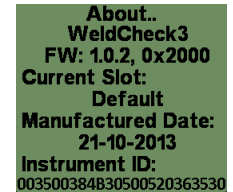

About..
WeldCheck3
FW: 1.0.2, 0x2000
Current Slot:
Default
Manufactured Date:
21-10-2013
Instrument ID:
003500384B30500520363530

4.2.3.6 Lock

The AeroCheck3 can restrict access to any menu item. Any menu item that has a picture of a Padlock after its name is locked.

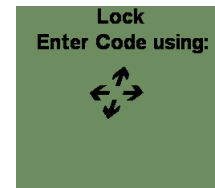

This means that its value can be read but not adjusted.

Some menu items such as Load/Save can still be entered but if locked then files can only be loaded and not saved or deleted.

Locking and Unlocking Process

Entering Lock Mode - First, to change the locked status of a Menu Item the instrument must be in LOCK mode. To enter this mode first select the Menu Item LOCK within the CONFIGURE Menu Group. The user will now be prompted to enter the LOCK code. This code is entered by using the **Up, Down, Left, Right** keys. By default, the code is **L, L, U, D, L**. Once entered correctly the Lock Menu will display the instructions to Lock and Unlock Menu items, which are repeated below.

Locking/Unlocking - Once in Lock Mode the Lock status of a Menu Item is toggled by highlighting the Menu Item and then holding down the Menu/Back key. Once the desired Menu Items have been set the machine must be rebooted to leave Lock Mode.

4.2.4 Display Pane

4.2.4.1 Graticule

Settings for the display graticule for pane 1 and pane 2

- Type: None, Grid, Polar, Time base or Meter (context sensitive).
- Size: 5 – 50 % in 5%

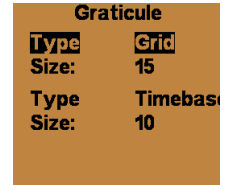

4.2.4.2 Spot

Settings for how the spot is drawn to the screen in Pane 1 and Pane 2

- Size: To enhance the spot visibility choice of 1*1, 2*2 or 3*3 pixels
- Colour: Sets spot colour
- Co-ordinates: Displays numeric position of spot None, X, Y or Theta, R



4.2.4.3 Offset

Offset: Spot position offset for pane 1 and 2 in %.

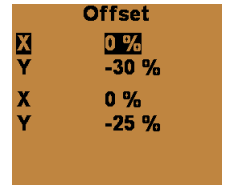

4.2.4.4 Persistence

Persistence and Time-base settings for Pane 1 and Pane 2

- Persistence – Time in Seconds that a point is visible in X-Y mode.
- Sweep – Time taken for a single sweep across the screen in Time base mode.
- TB Sweeps – Number of continuous Sweeps that are visible before being removed in Time base mode.
- Steps – The number of Steps that are visible in Waterfall mode.

Persistence	
Persistence	10s
Sweep	5.0s
TB Sweeps	1
Steps	2

4.2.4.5 Panes

Each Pane can have different Sources and Different type

- Pane 1: XY, Time-base, Waterfall and Meter with peak hold and percentage.
 - Source = Ch1, Ch2 or Mix with two sources possible
- Pane 2: Off, XY, Time-base, Waterfall and Meter with peak hold and percentage
 - Source = None, Ch1, Ch2 or Mix with only one source possible. Note: If Pane 1 has two sources, then Pane 2 cannot be on.
 - Size: Size 5-50%
Note: 50% = Equal sized left and right displays
 - Location: Up/Down to move Pane 2 position. Selectable from Top right, Bottom Right, Bottom Left, Top Left.

Panels	
Pane 1:	XY
Pane 2:	Time
Size:	35
Location:	↗↘

4.2.5 Advanced Pane

The advanced pane is where all the special functions of the instrument are located.

4.2.5.1 Alarm

Alarm: Audio and Visual Alarm

- Source:
 - Ch1 – Single Probe Single Frequency
 - Ch1/Ch2/Ch1&Ch2/Mix/Ch1&Mix – Single Probe Dual Frequency/Dual Probe
- Action: Audio Alarm, Freeze, Audio Alarm and Freeze, LED only (no freeze or audio)
- Stretch: Time alarm stays on after activation from 500ms to 10s.

Alarm	
Source	Ch1
Action	
Stretch	5 s

4.2.5.2 Alarm Zone

- Type: Off, Sector, Box

If Sector, then;

- Inner
- Outer
- Start
- Stop

If Box, then;

- Top
- Bottom
- Left
- Right

Alarm Zone	
Type	Box
Top	80%
Bottom	30%
Left	-40%
Right	10%

4.2.5.3 Attachments

Attachments are either screen shots (Picture) or recordings. By default, a screenshots file name is a date and time stamp with the date in reverse numerical order, this ensures that files are displayed in chronological order.

Load selected screen shot or recording.

Rename selected attachment.

Delete selected screenshot or recording.

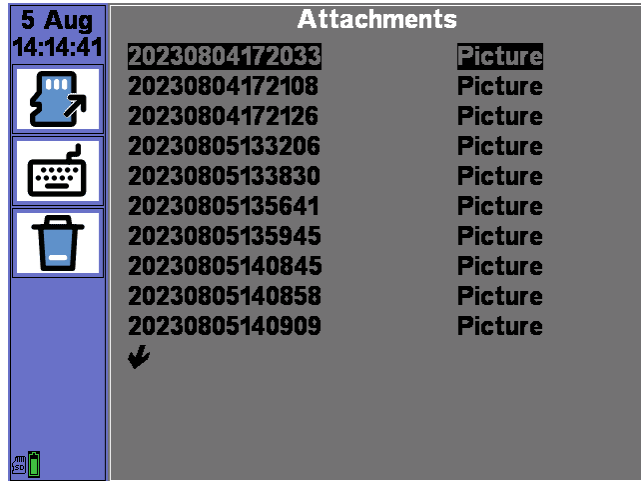

Note: Screen shots and Recordings are saved to the SD card. To appear on the Attachments Menu, they must be saved with the setting they are associated with.

To return to the Operating screen after recalling a screen shot press any key.

4.2.5.4 Guide Tool

The Guide Tool allows presentations uploaded to the instrument using ETHER Realtime Software to be viewed on the instrument whilst performing an inspection (see page 52).

Once entering the Guide Tool a menu showing all the available guides is shown. The Asterisk (*) denotes that this is the previously selected favourite for the currently recalled settings. Up/Down cursor keys highlight different guides.

Pressing OK will show a description in the red box at the bottom of the screen.

Select this Icon and press OK to display the guide as a slide show.

Select this Icon and press OK if you need to display individual files in the Guide.

Use this icon to make the currently highlighted Guide a favourite.

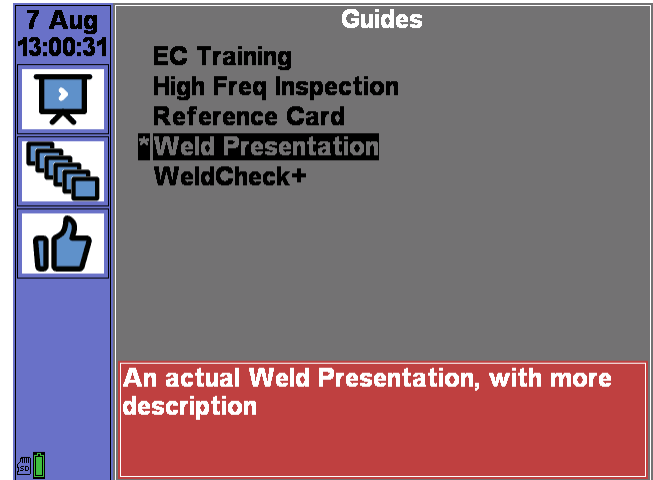

When a Guide is being displayed pressing OK will make the control bar appear.

Use the left/right cursor to highlight an icon and then press OK to activate.



Select the play icon to begin guide play back.



The symbol will then toggle to the pause play back.

Whilst a recording is playing there are several functions that can be used to view the recording.



= Return to start



= Advance one slide (same as right cursor key)

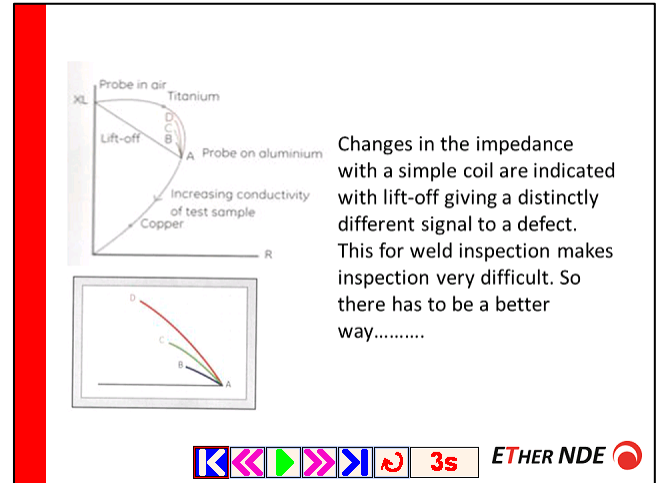



= Go back one slide (same as left cursor key)



= Go to end



= Exit Guide temporarily

To exit a Guide permanently press the Back/Menu Key.



= Select and then cursor up/Down alters duration between each slide in a guide being displayed.

If a Guide is exited temporarily then the Guide Icon appears in the Menu Side Bar.

Selecting the Guide Icon (Book) then causes a lower tool bar to appear that gives the option of returning to the Show or Exiting the Show.

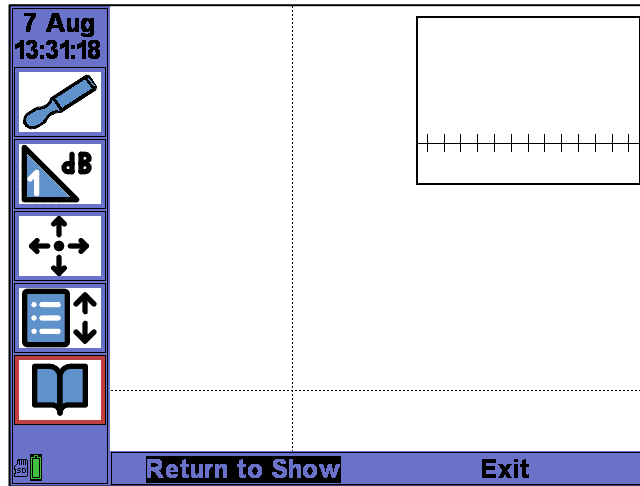

4.2.5.5 Creating a Guide Tool Presentations

Creating your 640 x 480 pixels device independent bitmap files from PowerPoint:

Open your PowerPoint presentation you would like to turn into a guide:

1. On the **Design** tab of the Ribbon, locate **Slide Size** in the **Customize** group, near the far right end of the toolbar.



2. Select **Slide Size**, and then select **Custom Slide Size**.

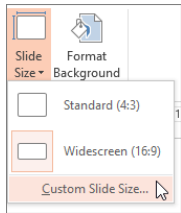

The **Slide Size** dialog box opens.

3. In the **Slide Size** dialog box, ensure the orientation is set the way you want it.
4. In the **Height** and **Width** boxes, PowerPoint accepts measurements in *inches*, *centimetres*, or *pixels*. Type a number followed by a space and then the appropriate abbreviation: in, cm, or px. **Must be set to 640x480 px or 16.933x12.7cm**

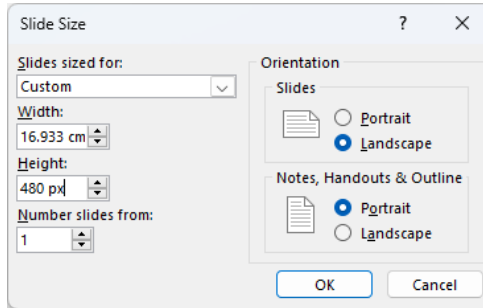
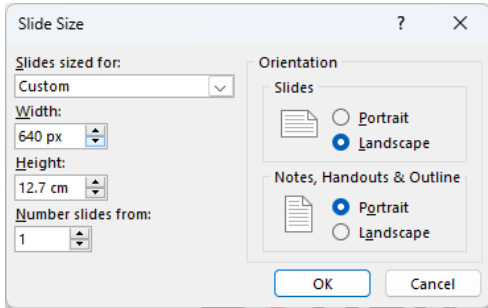

5. Go to **File, Save As**, select **Device Independent Bitmap**, select save, select **All Slides**

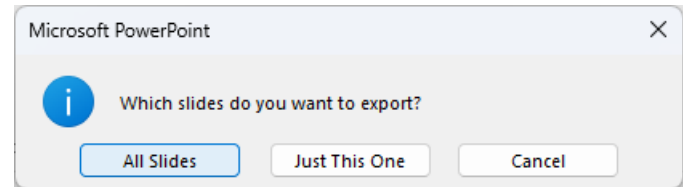
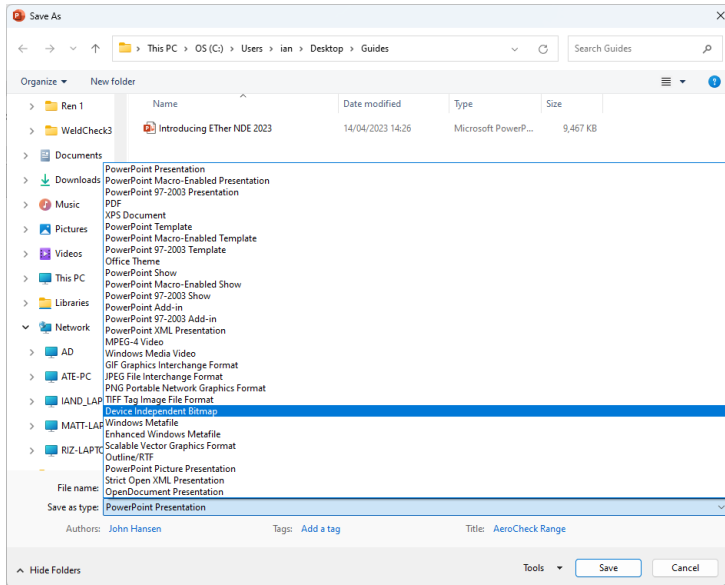

This will then create a new folder:

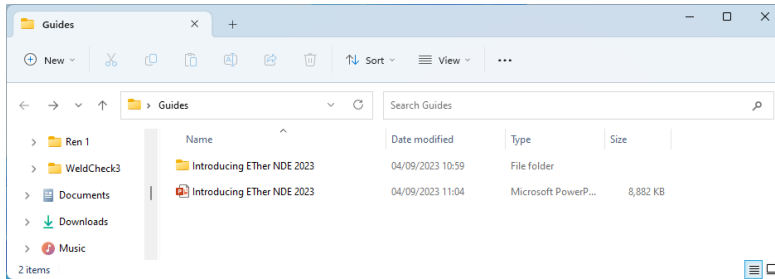

Within it should be all your slides as independent .bmp files.

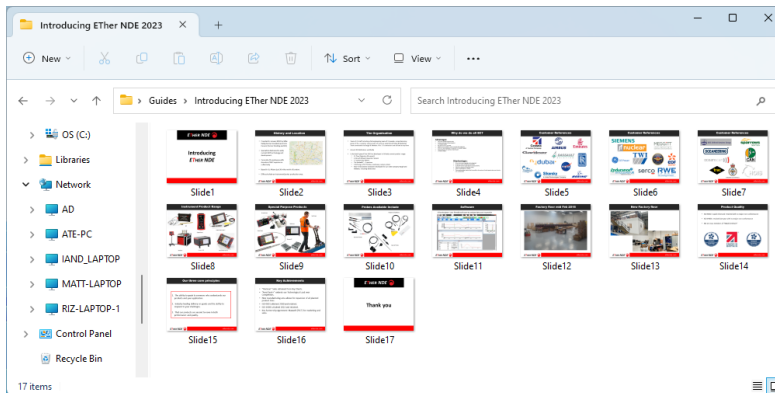

6. Load ETHERRealTime software onto your PC (See section 8.3)
7. Double click on icon to open software.
8. Select the Guides tab at the top of the screen:

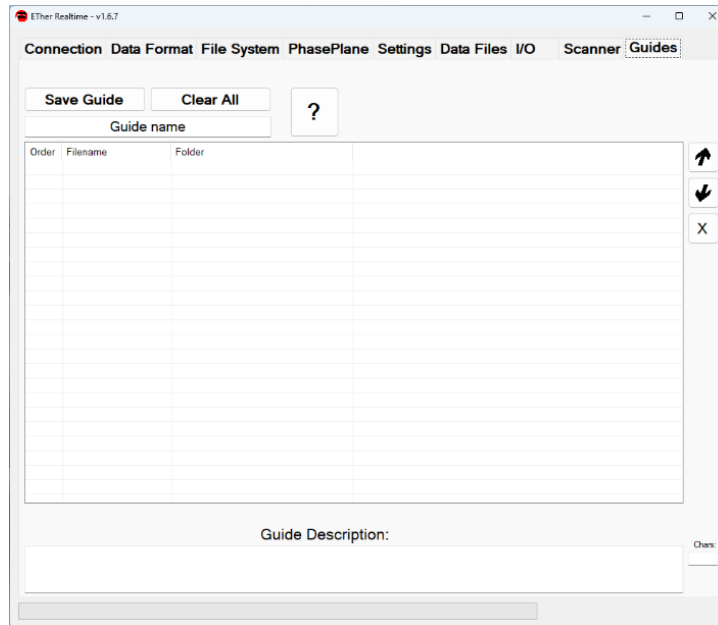

9. Drag all your 640x480 bitmap slides from explorer into the above window
10. Add a new Guide Name and Description (max. 255 characters)
11. Order the slides using the arrows.
12. Select Save Guide, select location and OK:

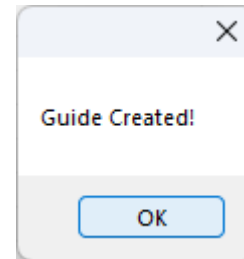
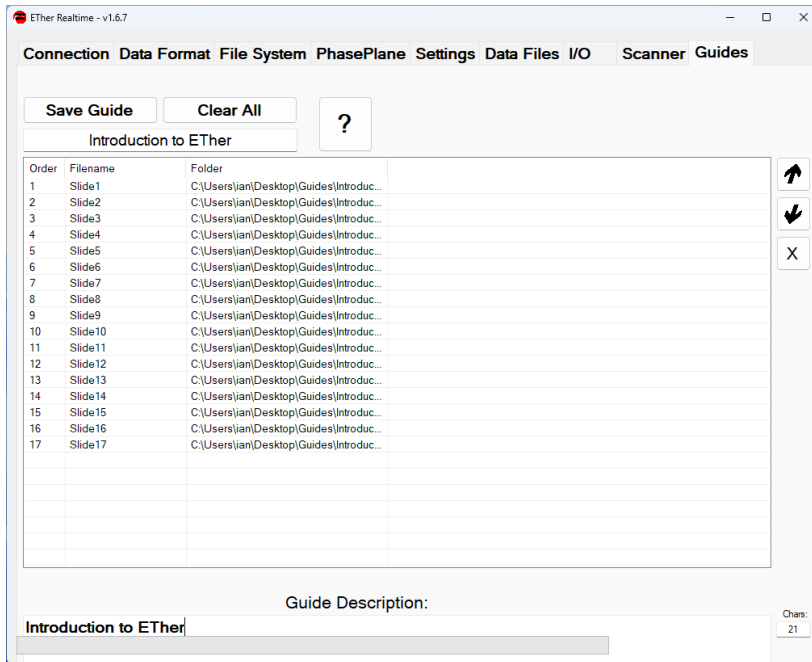

13. All this data will be saved as a new folder, including the below text file:

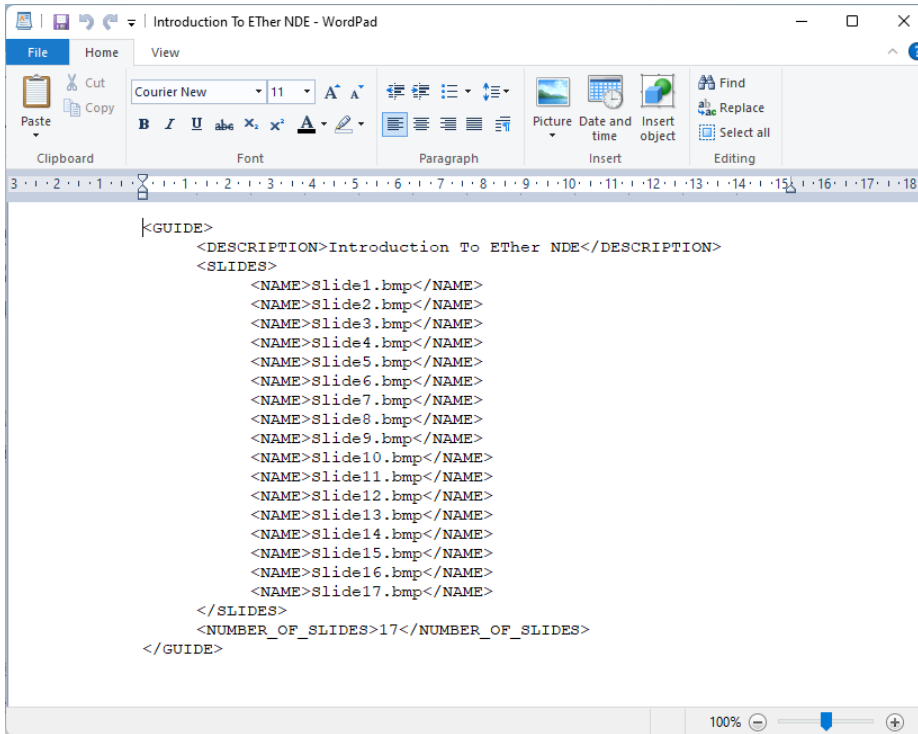

14. Copy the newly created folder onto the SD card of the instrument within the following Guides folder:
D:\EtherCheck\Guides

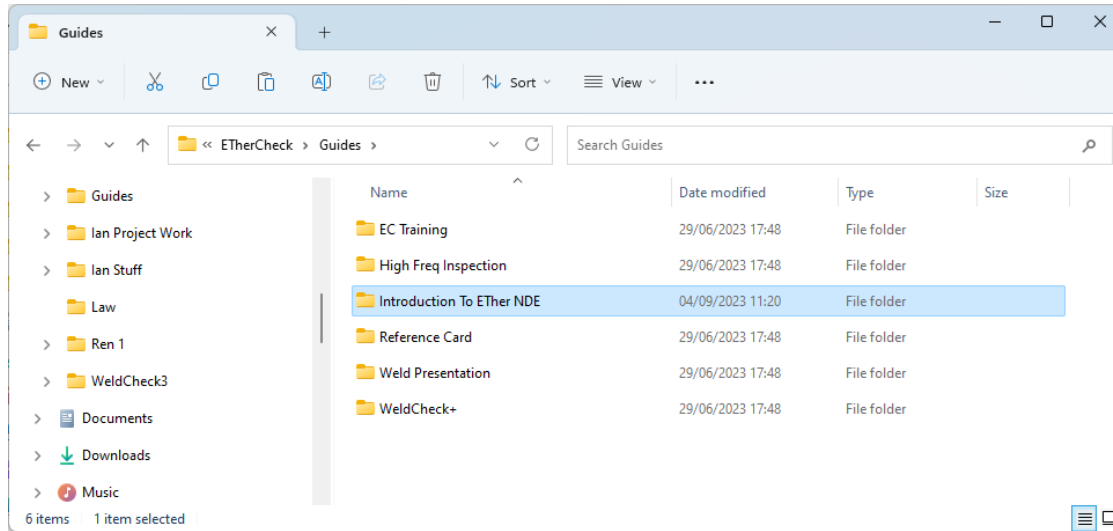

This can be done in 2-ways:

- By removing the SD card
 - Remove SD card from the instrument and place into a PC reader.
 - Copy the guide folder into \EtherCheck\Guides
 - Safely eject the card and return it to the instrument.

- Using ETHER Realtime
 - Connect the instrument to a PC via a USB lead
 - Turn instrument on
 - Open ETHERRealTime
 - Go to the Connection tap and select **Connect**

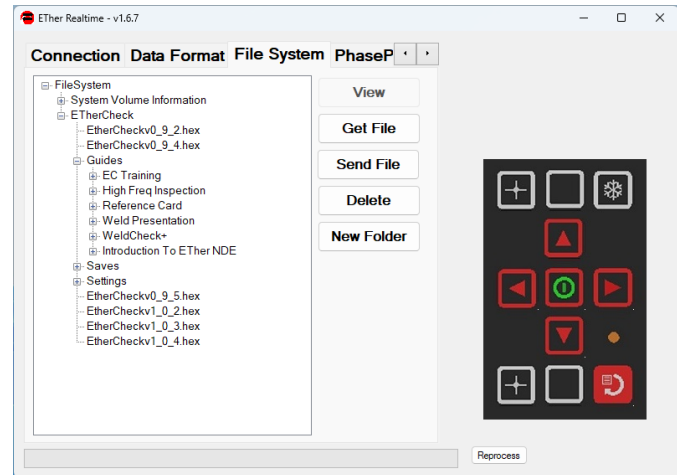
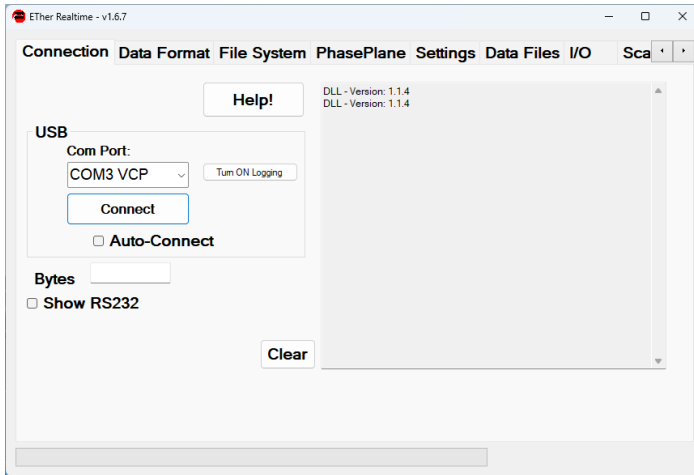

- Got to the File System tab
- **Expand FileSystem\ETHERCheck\Guides**
- Drag the newly created guide folder into Guides
- Return to the Connection tap and select **Disconnect**

4.2.5.6 Open New Guide on AeroCheck3

1. Turn on instrument, press the Red Menu button, select Guides, press OK



2. Highlight the guide you would like to view using the up and down arrow, then press the left arrow which will highlight the top side show Icon, press the green button to view:



3. Slideshow should begin, scrolling between each slide in turn.

4.2.5.7 Record & Replay Function

The Record & Replay Function allows data to be captured for up to 150s. This data may then be saved on the instrument, replayed either on the instrument or transferred to a PC and analysed using the utility ETHERAnalyser. Captured data can be analysed in greater detail by zooming in on the collected data and also a recording can be used to optimise the equipment settings such as Filter, Gain and Phase in a consistent matter.

1. To use this sequence first place the Record & Replay Icon on the Side Bar (see 5.2.1)
2. Then return to the operating screen and select the Record & Replay Icon (camera).

A special tool bar will be displayed at the bottom of the screen. On right is the data sample rate used for the data recording. During the recording a grey cursor moves across the screen and the time display on the right is updated. The Grey cursor width indicates the time duration of the on screen persistence). The activity symbol (lower right) is animated to indicate activity.

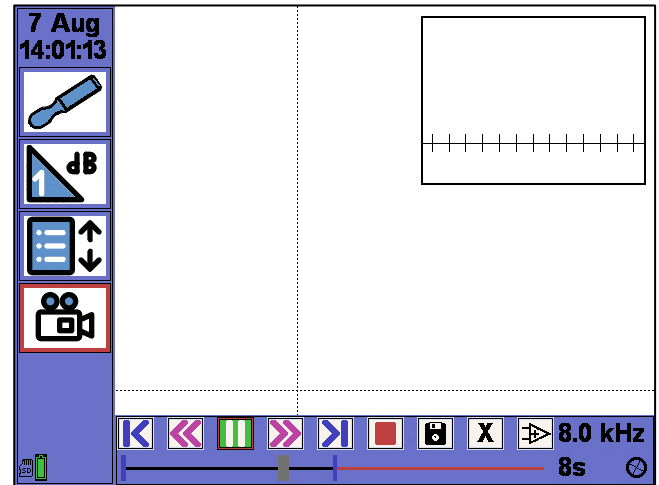
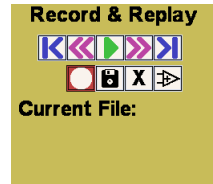

3. Using the cursor keys and the Enter Key select the item required. A red box surrounds the symbol selected.

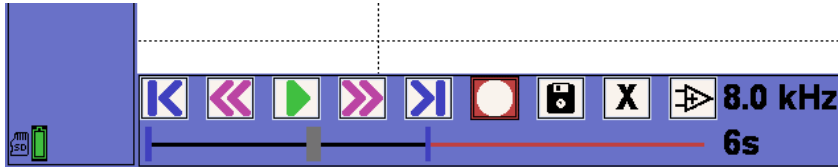

= The Record Item Symbol toggles between the record state and the stop state. Select to record (note when selected the Icon Colours Reverse to denote the symbol is selected).



= When the symbol is selected it changes to the Stop Symbol and the recording continues until is selected again. Should the recording length be exceeded the recording is always of the last 150 seconds.

Whilst a recording is playing there are several functions that can be used to view the recording.



= Return to start



= Return to finish



= Slow down replay



= Speed up replay



= Select the play icon to begin data replay



= The symbol will then toggle to the pause symbol.

You can also leave the recording function using the Back Key and the recording will continue running. This then allows settings to be altered and the result viewed. This can be useful when calibrating in a dynamic test as the data settings be optimised off-line. To return to the Record & Replay function then select the Record & Replay Icon.

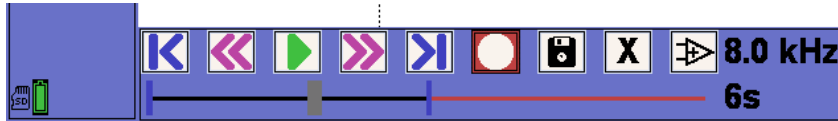

To zoom in on a specific part of the recording move the blue cursor bars at each end of the recording. Press the down cursor key and the left or right to select a cursor. The selected cursor turns red when selected. Then press the Enter key and the cursor turns green. Use the left and right keys to move the cursor. The display on the right shows the cursor position in time. When in the correct position press the Enter key again and the colour of the highlighted cursor changes from green to red. Use the cursor keys to move the selection focus to the required cursor. Then press Enter and use the Left and Right cursor keys to select the other cursor.

 = Save recording. The User is prompted for a file name. Saved record may be replayed at any time by loading the item in the Attachments function see 5.2.5.3 Recordings are saved to the SD card in order to appear on the Attachments Menu they must be saved with the setting they are associated with.

 = Exit Record & Replay Function and return to the Operating screen.

 = Auto mix function. Record a signal to suppress and press the centre enter key for the instrument to automatically derive the optimal mixing coefficients.

4.2.5.8 Auto Phase

This provides an automatic means of setting the phase in any required orientation.

- Angle: the required angle measured from the usual 9 o'clock lift off position as zero degrees and then rotating clockwise.
 - Radius: Sets the threshold crossing for the phase setting to be triggered at.
- Set user programmable soft keys to activate this function.
 - Press programmed key
 - Balance probe on calibration block, lift probe, the lift off signal should break the 25% red threshold
 - The lift off signal should now be at 9 o'clock

Auto Phase		
Angle	0.0	°
Radius	25	%

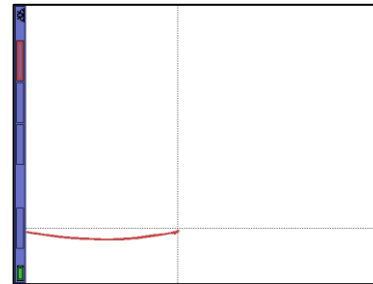
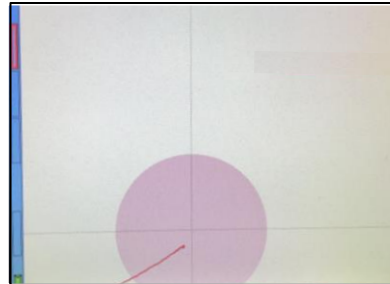
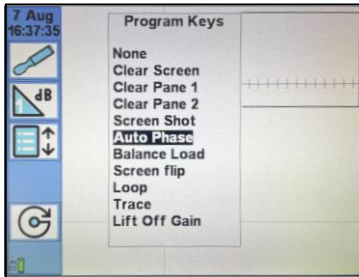

5 Setting the AeroCheck3 to perform an inspection.

5.1 *With a configuration file*

If you have a configuration file for the probe, load the setting file as described in section 5.4. It is a recommended practice to validate that the settings loaded by the software are correct for the probe type. To do so press MENU, go on the Probe and Frequency tab, and verify the settings. Then following this ensure that the response from the calibration reference standard is as per the procedure the inspection is being performed to. Press MENU when finished.

5.2 *With no configuration files*

1. First press the MENU,
2. Set the gain to about 40 dB. Make sure the Gain Lock is set do Y=X.
3. Set the Probe; set the Type. Load and Frequency as required.
4. Set the filters for manual inspection as High Pass = DC and Low Pass = 300Hz
5. Set the display type you require to use with the Display configuration.
6. Adjust the gain and phase to obtain the response required by the inspection procedure.

5.3 *Sample application setup*

By default, the instrument has several preloaded factory setups.

These may be reviewed in the Load & Save function:

- Weld – 100kHz setting for weld inspection
- Paint – 100kHz using Lemo 00 for paint coating assessment as in Weld Inspection
- Weld Dual Probe - 100kHz settings for Weld and Paint Inspection

- Weld Single Probe Dual Channel – 100kHz setting to use a Weld Probe for both inspection and paint thickness.
- 2MHz Absolute – using the Lemo 00 for Surface defect detection
- 200kHz Absolute – using the Lemo 00 for Surface defect detection
- 500kHz Absolute – using the Lemo 12 way for Surface defect detection
- PUR16 Reflection – Low Frequency 10kHz for sub-surface testing on non-ferrous material
- ID Probe-MIX -21kHz and 18kHz ID Tube inspection mix
- SPOT DUAL MIX – 5kHz and 20kHz Liftoff/probe wobble mix, Aerospace sub-surface testing

The above settings may be used as a starting point for a wide range of inspections using.

5.3.1 High Frequency Surface Inspection

These notes are offered as a guide to help carry out a test for surface inspection using High Frequency Eddy Currents. There are three high frequency surface inspection tests on the instrument;

- 2MHz Absolute – using the Lemo 00
- 200kHz Absolute – using the Lemo 00
- 500kHz Absolute – using the Lemo 12 way

5.3.1.1 Equipment Required:

Probes and cables;

- 200kHz Absolute - PS200PD064-114N and Lead, Lemo 00 to Microdot - ALLCX-M02-015A
- 500kHz Absolute – PS500PC195-114N and Lead, Lemo 12-Way to Microdot – ALL12-M02-015A
- 2MHz Absolute – PS002PS066-152N and Lead, Lemo 00 to Microdot - ALLCX-M02-015A

Test Blocks;

- Aluminium 7075-T6 with 3 slots 0.2, 0.5, 1.0mm – ATBA
- Titanium with 3 slots 0.2, 0.5, 1.0mm – ATBT
- Stainless Steel with 3 slots 0.2, 0.5, 1.0mm – ATBS
- Ferrous Steel (EN1A) with 3 slots 0.2, 0.5, 1.0mm – ATBF
- Magnesium with 3 slots 0.2, 0.5, 1.0mm – ATBM
- Steel with 3 slots 0.5, 1.0, 2.0mm and 4 off 0.5 mm shims (Weld Inspection)- ATBW

5.3.1.2 Setup:

1. Connect probe to cable and connect to the instrument.
2. Switch instrument on.

3. Press Menu.
4. Use the cursors to scroll the menu until Load & Save is highlighted, press Enter key. Use the up down cursor to select Required Setup, select the load icon and press Enter
5. The main Operating screen will appear as soon as the setup has been recalled.
6. Place the probe on the Reference Standard (away from EDM notches) normal (90°) to the surface
7. First set the load using the Auto Load Option in the Probe Menu and assign one of the soft keys (see 2.3.2)
8. Then carry out Balance/Lift off function setting Auto Phase under advanced at 0 degrees and radius 50%. Then assign the other soft key to Auto Phase.
9. Scan the probe over the 0.5 mm EDM notch and note signal response.
10. If more or less sensitivity is required, use the Gain (dB key) or Quick-Menu to increase or decrease signal amplitude as required.
11. Adjust the phase to set the lift off horizontal by either using the Auto Phase Key (assigned above) or Probe Phase Item or the Quick-Menu Phase Item.
12. Carry out scan of the component.

Note:

1. If you use a different Frequency probe remember to adjust Frequency setting on the instrument to match the probe. The balance load will also need to be set to match the probe see 5.2.2.1
2. Where possible always use a Reference Standard, which is a similar material to that which is to be inspected.
3. Always try and keep the probe normal (90°) to the surface of inspection, especially if scanning in a radius.

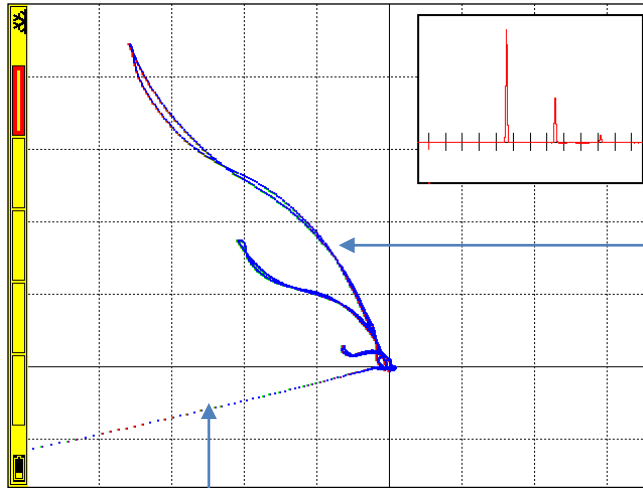

Three Notch Responses

Lift off

5.3.2 Low Frequency Sub-Surface Inspection

These notes are offered as a guide to help carry out a test for low frequency sub-surface inspection using Low Frequency Eddy Currents.

5.3.2.1 Equipment Required:

Probes	= Probe, Surface, Right Angled, Dia 16mm 300Hz - 100KHz, Plastic, Lemo 4-Way – PUR16
Cable	= Accessory, Lead, Lemo 12-Way - Lemo 4-Way, 1.5m (Reflection) – ALL12-L04-015R
Test Piece	= Accessory, Test Block, Aluminium 7075-T6, 1.6mm Thick, x4 Flat Bottom Holes 75%(1.2mm), 50%(0.8mm), 25%(0.4mm), 12.5%(0.2mm), Deep – ATB001

5.3.2.2 Setup:

1. Connect probe to cable and connect to the instrument.
2. Switch instrument on.
3. Use the cursors to scroll the menu until Load & Save is highlighted, press Enter key. Use the up down cursor to select PUR16 REF, select the load icon and press Enter
4. The main Operating screen will appear as soon as the setup has been recalled.
5. Place the probe on the Reference Standard with the flat-bottomed holes facing downwards.
6. Then carry out Balance/Lift off function setting Auto Phase under advanced at 0 degrees and radius 50%. Then assign the other soft
7. Scan the probe over the defects and note signal response.



key.

8. If a change to signal sensitivity is required, use the Gain (dB key) or Quick-Menu to increase or decrease signal amplitude as required.
9. Adjust the phase to set the lift off horizontal by either using the Probe Phase Item or the Quick-Menu
10. Carry out scan of component.

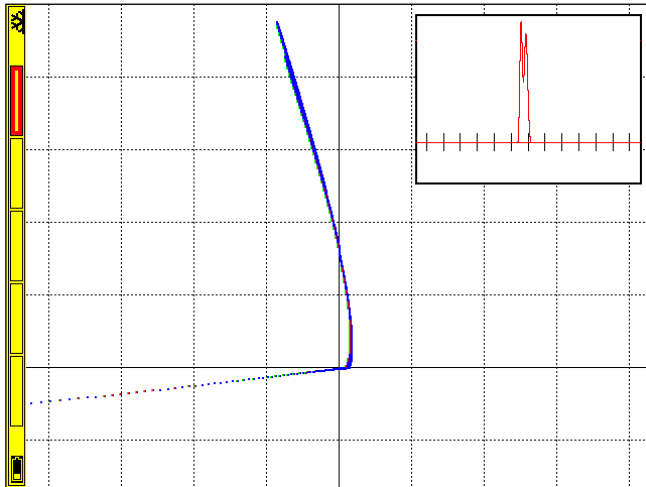

Note:

1. Use your finger as a guide along the edge of the test piece. This will help maintain the same probe to edge distance.
2. Always try and keep the probe normal (90°) to the surface of inspection.

5.3.3 Rotary Setting

These notes are offered as a guide to help carry out a hole inspection using a rotary drive.

5.3.3.1 Equipment Required:

Probe	= Probe. Rotating, Rigid, Dia = 11.10mm, wl = 65 mm - PRR1111-065
Cable	= Accessory, Lead, Lemo 12-Way - Lemo 12-Way, 2.0m (Rotating Drive) - ALL12-L12-020M
Rotating Drive	= Accessory, Rotating Drive, Small, Lemo 12-Way (MERCURY) - ARD002
Test Piece	= Accessory, Test Block, Rotating probe, Total 12 holes; 3/16", 1/4", 5/16", 3/8", 7/16", 1/2" 6 sound holes and 6 holes with 0.7mm dia. side drilled holes - ATB005

5.3.3.2 Setup:

1. Connect probe to cable and connect to the instrument.
2. Switch instrument on.
3. Use the cursors to scroll the menu until Load & Save is highlighted, press Enter key. Use the up down cursor to select ROTARY, select the load icon and press Enter

4. The main Operating screen will appear as soon as the setup has been recalled.
5. Press Balance
6. Start the drive rotating by pressing the key on the drive.
7. Pass the probe through the hole with the defect.
8. If change to signal sensitivity is required, use the Gain (dB key) or Quick-Menu increase or decrease signal amplitude as required.
9. Adjust the phase to set the defect signal vertical by either using the Probe Phase Item or the Quick-Menu
10. Adjust the High and Low Pass filters to get the appropriate signal.
11. Carry out scan of component.

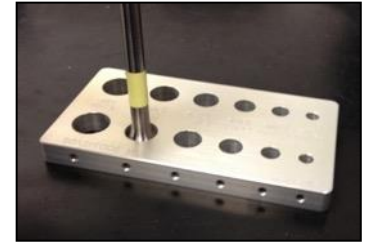

to

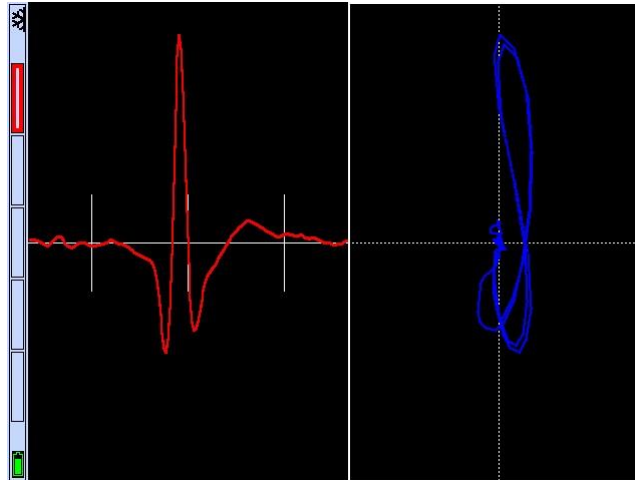

In scheme - Dark

5.3.4 Dual Frequency Mixing

5.3.4.1 Principle of mixing

The principle of dual frequency mixing is that at different frequencies different signal indications (e.g. lift off and defect) have a different relative phase and amplitude response. By means of phase rotation and Gain change of the X Y signal components one of these indications can be manipulated to be nearly the same in phase and amplitude as the other and then by subtraction (mixing) the unwanted component is minimised giving an improved detection of the unwanted signal. Channel 1 is the primary channel and as such is not manipulated in the Auto Mix process whereas Channel 2 is the secondary channel. It is good practise for the secondary channel to be set so that it is relatively more sensitive to the unwanted signal than the wanted signal.

Although this example is for a low frequency mix this is equally applicable to other absolute probe mixes and the procedure and principles are widely applicable.

NOTE; mixing inevitably causes an increase in the electronic noise (grass).

5.3.4.2 Example of mixing

The conventional example of mixing is to use a non-ferrous tube and minimise the effect of a ferrous support ring however here we demonstrate mixing out lift off on a low frequency test. This test uses 5kHz on Channel 1 and 20kHz on Channel 2.

5.3.4.3 Equipment Required:

Probe	= Probe, Surface, Right Angled, Dia 16mm 300Hz - 100KHz, Plastic, Lemo 4-Way – PUR16
Cable	= Accessory, Lead, Lemo 12-Way - Lemo 4-Way, 1.5m (Reflection) – ALL12-L04-015R
Test Piece	= Accessory, Test Block, Aluminium 7075-T6, 1.6mm Thick, x4 Flat Bottom Holes 75%(1.2mm), 50%(0.8mm), 25%(0.4mm), 12.5%(0.2mm), Deep – ATB001

5.3.4.4 Setup:

1. Connect probe to cable and connect to the instrument.
2. Switch instrument on.
3. Use the cursors to scroll the menu until Load & Save is highlighted, press Enter key. Use the up down cursor to select DUAL SPOT MIX, select the load icon and press Enter
4. The main Operating screen will appear as soon as the setup has been recalled.
5. Place the probe on the Reference Standard with the flat-bottomed holes facing downwards.
6. Then carry out Balance/Lift off function setting Auto Phase under advanced at 0 degrees and radius 50%. Then assign the other soft key.
7. Scan the probe over the defects and note signal response.
8. If change to signal sensitivity is required, use the Gain (dB key) or Quick-Menu to increase or decrease signal amplitude as required.

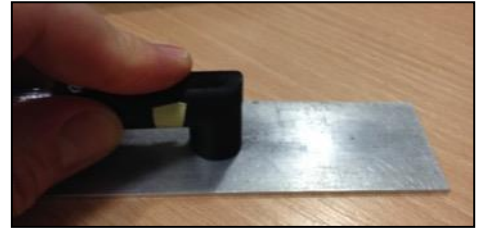

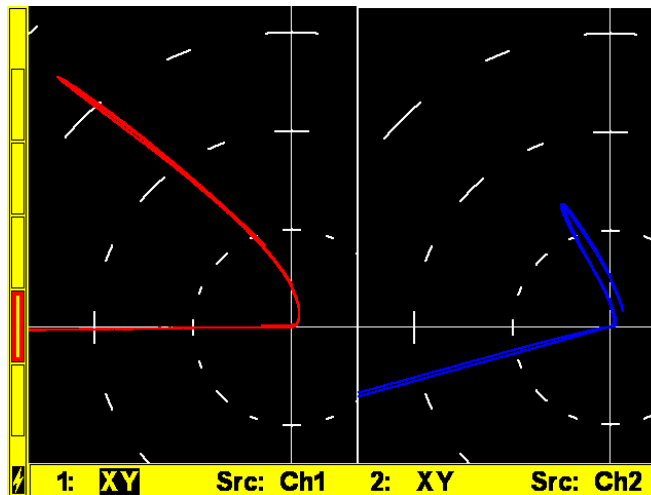

9. Set the panes to display channel 1 and channel 2 as shown.
10. Repeat the setting for channel 2 so that the display looks like the screen above.
11. Now in the Record function record the lift off whilst gently rocking the probe. Press Stop to complete.



12. Then select the Auto Mix function



13. Once the message “Auto Mix Complete” is displayed return to the operating screen by selecting Exit

14. The display will now look like this.

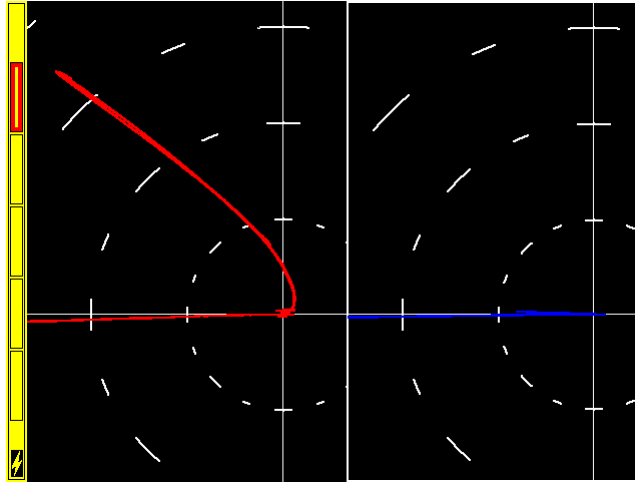

15. Now adjust the Pane setting to show the Mix channel in pane 2.

16. Adjust the Mix phase to set the signal as required by either using the Probe Phase Item or the Quick-Menu.

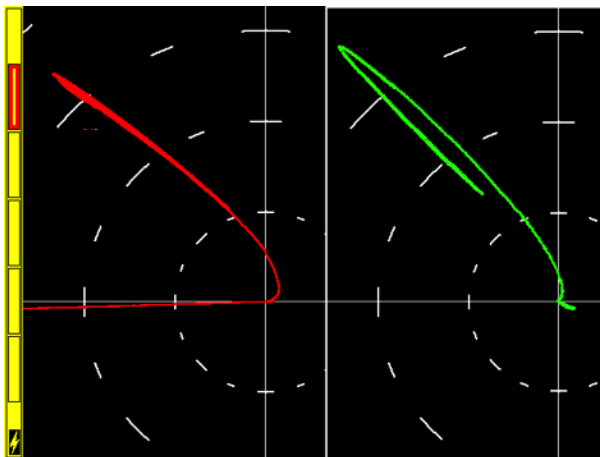

17. The mix is now complete

Note:

1. Use your finger as a guide along the edge of the test piece. This will help maintain the same probe to edge distance.
2. Always try and keep the probe normal (90°) to the surface of inspection.

5.3.5 Conductivity

These notes are offered as a guide to help carry out a conductivity inspection using probe ETHER Probe PCON001 only. The probe has an internal memory that stores the probe characteristics for calculating conductivity. Only one test frequency is configured for this probe.

5.3.5.1 Equipment Required

Probe, Conductivity, 60kHz, Dia 13.00mm, Straight, Lemo 7-Way (AeroCheck Plus) – PCON001
Accessory, Lead, 12-Way Lemo to 7-Way Lemo, 0.7m, Conductivity – ALL12-L07-012-CON
Accessory, Dual Conductivity Reference Standard – ASIG014
REFERENCE HOLDER - Dual Conductivity Standard, (Thermal Bridge for Stability) – 40517

5.3.5.2 Setup:

1. Switch instrument on.
2. Connect probe to cable and connect to the instrument.
Instrument will auto detect the probe and go into conductivity mode, as shown:

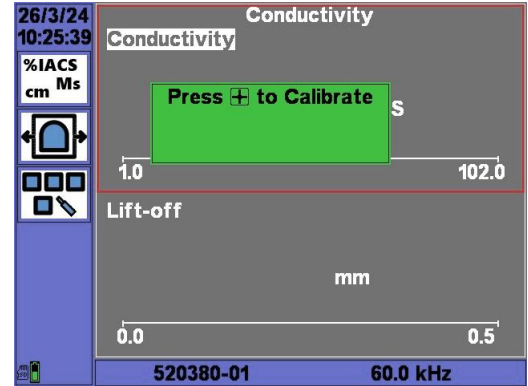

3. Press left arrow and select the calibrate icon:



Set the CB1 and CB2 values to those on your reference standard. Scroll down and enter CB1 and CB2 %IACS values as shown on Dual Conductivity Reference Standard, press the back button, the unit will then go back to the main calibration screen.

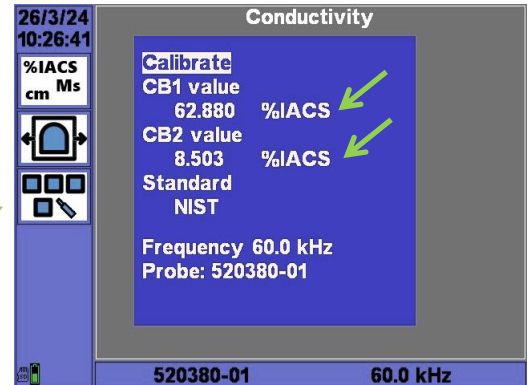

4. Press the up arrow to select the Alarm icon. Set your alarm gate values as required, press the back button, the unit will then go back to the main calibration screen.

(You can set the alarm range for both conductivity value and lift-off. First select the required display panes as the two displayed panes. Then select this icon with the cursor keys and press enter to select. The numeric value at the left end of the scale is highlighted press enter to edit the value. The Up Down Cursor Keys edit a digit and left right change the digit selected. Press enter to confirm selection. Press the right cursor key to move the selected numeric value and repeat the above procedure for each value to be edited.)

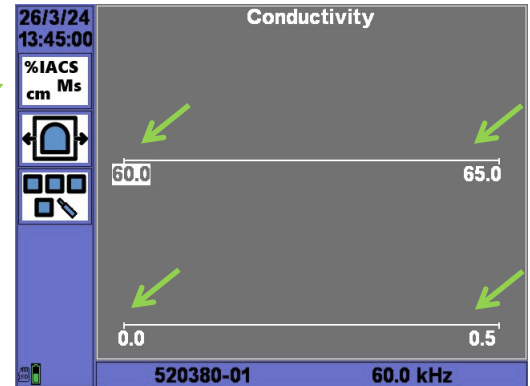

5. Press the up arrow to select the Units/Metal Sort icon. Set your units and Metal Sort values as required, press the back button, the unit will then go back to the main calibration screen.

(Move up down left column Units to scroll to Conductivity, Length or Display, press enter to select, then left right to select column and up down to change and then enter to validate)



Units Options:

Conductivity		Length		Display
Unit	Resolution	Unit	Resolution	Continuous
%IACS	No decimal point	mm	No decimal point	Single
$\mu\Omega\text{cm}$	1 decimal point	mil	1 decimal point	
MS/m	2 decimal points	Thou	2 decimal points	
	3 decimal points		3 decimal points	
	Auto (SigmaCheck)			
	AutoS (Legacy Instrument)			

6. Calibrate the probe by following the on-screen prompts.
7. Press Balance

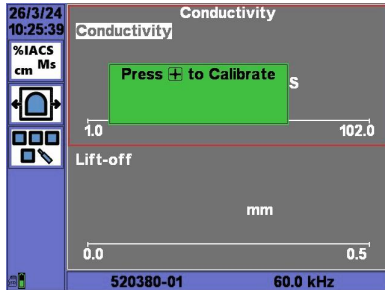

8. Hold probe in air, press enter when prompted to continue

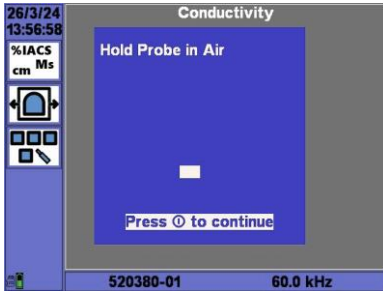

9. Place probe on CB1 block as shown, hold probe steady, press enter when prompted to continue

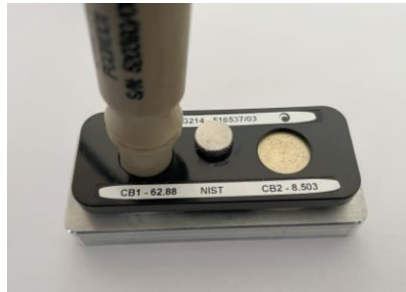

10. Place probe on CB2 block as shown, hold probe steady, press enter when prompted to continue

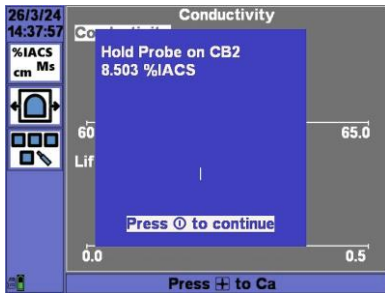

11. Once calibrated carry out measurement, example measurement shown:

Both the Top and Bottom Pane can be toggled between:

- Conductivity
- Metal Sort
- Min Thickness
- Lift-off

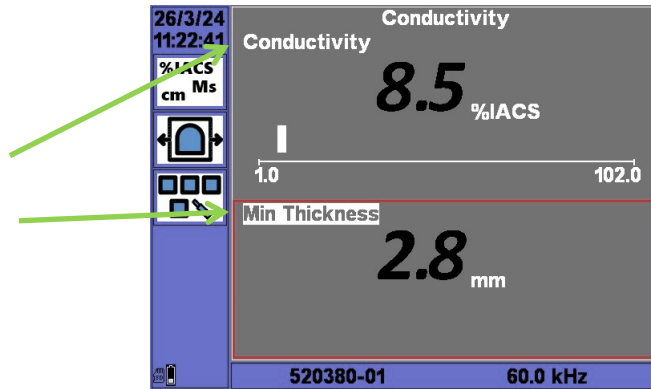

12. Disconnect the probe cable and the conductivity mode will exit and the instrument will return to its normal operation mode.

5.3.5.3 Additional Features

To Set display panes cursor right then up down to select pane to change then cursor right each key press changes display from Conductivity, Metal Sort, Minimum Thickness at measured conductivity and Lift Off/Non-conductive Coating thickness.

Tips for Accurate Measurements:

Always ensure that Probe, Dual Reference Block and Material to be tested are at the same temperature.

Re-calibrate the instrument every 15 minutes. There is a visual warning that the calibration needs to be repeated. Frequent calibration is the key to accurate measurement.

Try not to hold the face of the probe, dual reference block or material to be tested in your in your as this will change the temperature.

Specification:**Accuracy**

0.5%-10% IACS better than +/- 0.05% IACS

10%-25% IACS better than +/- 0.25% IACS

25%-60% IACS better than +/-0.5% IACS

60%-110% IACS better than +/- 1% IACS

Lift off corrected to 1.0 mm

No temperature compensation

All Errors at 90% Confidence Level

Resolution

3 decimal points max

Auto resolution mode AutoS= Legacy Instrument, Auto= SigmaCheck.

If this is not relevant in the AC3 then should delete this selection feature

6 Probes

6.1 Pencil Probes (Double Shielded) – Absolute/Bridge

Straight with plastic handle

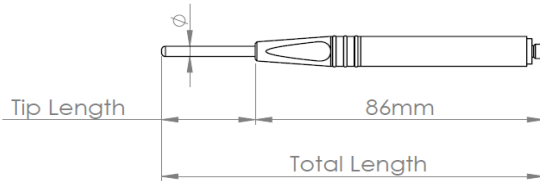

90deg Tip with plastic handle

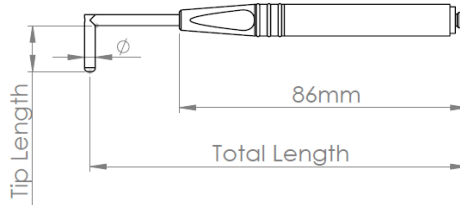

45deg Crank with plastic handle

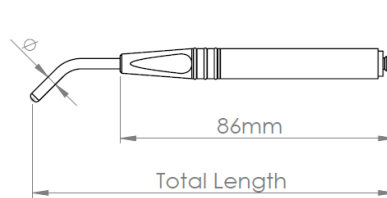

15deg Crank, 90deg Tip

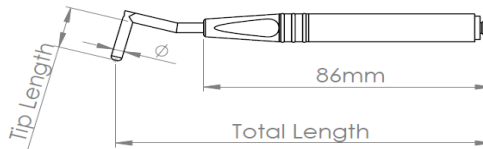

Application:

Absolute Pencil probes - for general purpose inspection of surface breaking defects and metallurgy variations, uses Micro connector.

Bridge Pencil probes – ETHER NDE newly developed “IB Tech Inside” absolute intrinsically balanced technology which further improves the signal to noise ratio of conventional absolute probes giving a significant improvement in inspection reliability, uses Lemo 4-Way connector.

Specification:

- Double Shielded, used on Fe & NFe applications
- Non-Magnetic Stainless-Steel Shanks - Straight, 90deg Tip, 45deg Crank, 15deg crank + 90deg Tip
- Plastic Handle with finger scallops and neoprene grip
- Connector – Micro for absolute and Lemo 4-Way for bridge (IB Tech Inside)
- Centre frequency/Operating range – 200kHz (50kHz – 600kHz), 500kHz (150kHz – 1.5MHz), 2MHz – (650kHz – 6MHz), 6MHz – (2MHz – 18MHz)

6.1.1 Straight – Absolute with plastic handle coding:

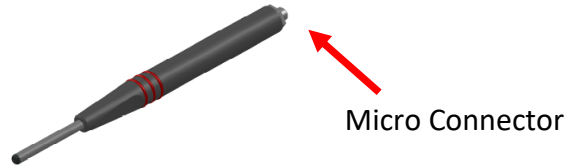
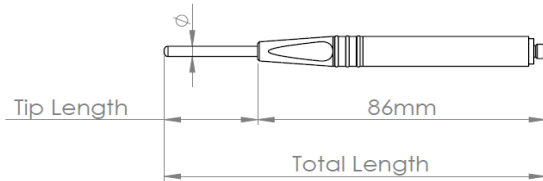

Standard

ETHer NDE Part No.	Centre Frequency	Tip Length (Total Length)	ØTip	Type
Probe, Shielded, Plastic Handle, Straight:				
PS200PS028-114N	200kHz	28mm Tip Length (Total Length 114mm, 4.5") (Straight Shank)	4.45	Absolute
PS200PS028-114F	200kHz	28mm Tip Length (Total Length 114mm, 4.5") (Straight Shank)	3.30 (Fine)	Absolute
PS500PS028-114N	500kHz	28mm Tip Length (Total Length 114mm, 4.5") (Straight Shank)	4.45	Absolute
PS500PS028-114F	500kHz	28mm Tip Length (Total Length 114mm, 4.5") (Straight Shank)	3.30 (Fine)	Absolute
PS002PS028-114N	2MHz	28mm Tip Length (Total Length 114mm, 4.5") (Straight Shank)	3.30	Absolute

PS002PS028-114F	2MHz	28mm Tip Length (Total Length 114mm, 4.5") (Straight Shank)	2.34 (Fine)	Absolute
PS006PS028-114N	6MHz	28mm Tip Length (Total Length 114mm, 4.5") (Straight Shank)	2.34	Absolute

Other variants available on request.

Leads to fit above probes:

ETHer NDE Part No.	Description	Connector Instrument End	Connector Probe End	Cable Length	Configuration
ALLCX-M02-015A	Lead	Lemo Coaxial	Micro Plug	1.5m	Absolute
ALL12-M02-015A	Lead	Lemo 12-Way	Micro Plug	1.5m	Absolute

6.1.2 Straight – Bridge (IB Tech Inside) with plastic handle coding:

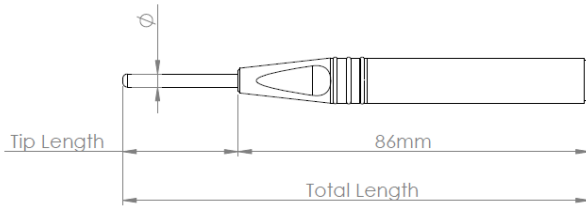

4-Way Lemo Connector

Standard

ETHer NDE Part No.	Centre Frequency	Tip Length (Total Length)	ØTip	Type
Probe, Shielded, Plastic Handle, Straight:				
PS200PS028-114NB	200kHz	28mm Tip Length (Total Length 114mm, 4.5") (Straight Shank)	4.45	Bridge
PS200PS028-114FB	200kHz	28mm Tip Length (Total Length 114mm, 4.5") (Straight Shank)	3.30 (Fine)	Bridge
PS500PS028-114NB	500kHz	28mm Tip Length (Total Length 114mm, 4.5") (Straight Shank)	4.45	Bridge
PS500PS028-114FB	500kHz	28mm Tip Length (Total Length 114mm, 4.5") (Straight Shank)	3.30 (Fine)	Bridge

PS002PS028-114NB	2MHz	28mm Tip Length (Total Length 114mm, 4.5") (Straight Shank)	3.30	Bridge
PS002PS028-114FB	2MHz	28mm Tip Length (Total Length 114mm, 4.5") (Straight Shank)	2.34 (Fine)	Bridge
PS006PS028-114NB	6MHz	28mm Tip Length (Total Length 114mm, 4.5") (Straight Shank)	2.34	Bridge

Other variants available on request.

Leads to fit above probes:

ETHer NDE Part No.	Description	Connector Instrument End	Connector Probe End	Cable Length	Configuration
ALL12-L04-015B	Lead	Lemo 12-Way	Lemo 4-Way Plug	1.5m	Bridge

6.1.3 90deg Tip – Absolute with plastic handle coding:

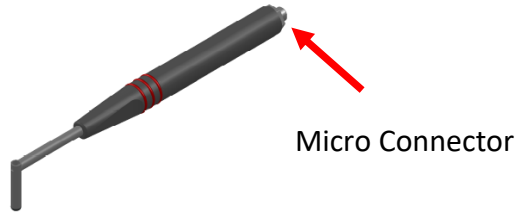
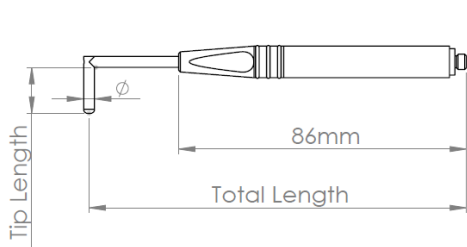

Standard

ETHer NDE Part No.	Centre Frequency	Tip Length (Total Length)	ØTip
Probe, Shielded, Plastic Handle, Right angled 90deg Tip:			
PS200PR050-114N	200kHz	5.0 (MIN) Tip Length (Total Length 114mm, 4.5") (90deg Tip Shank)	4.45
PS200PR027-114F	200kHz	2.7 (MIN) Tip Length (Total Length 114mm, 4.5") (90deg Tip Shank)	3.30 (Fine)
PS500PR050-114N	500kHz	5.0 (MIN) Tip Length (Total Length 114mm, 4.5") (90deg Tip Shank)	4.45
PS500PR027-114F	500kHz	2.7 (MIN) Tip Length (Total Length 114mm, 4.5") (90deg Tip Shank)	3.30 (Fine)

PS002PR027-114N	2MHz	2.7 (MIN) Tip Length (Total Length 114mm, 4.5") (90deg Tip Shank)	3.30
PS002PR017-114F	2MHz	1.7 (MIN) Tip Length (Total Length 114mm, 4.5") (90deg Tip Shank)	2.34 (Fine)
PS006PR017-114N	6MHz	1.7 (MIN) Tip Length (Total Length 114mm, 4.5") (90deg Tip Shank)	2.34
Please see matrix below for other options, specials available on request.			

Other variants available on request.

Leads to fit above probes:

ETHer NDE Part No.	Description	Connector Instrument End	Connector Probe End	Cable Length	Configuration
ALLCX-M02-015A	Lead	Lemo Coaxial	Micro Plug	1.5m	Absolute
ALL12-M02-015A	Lead	Lemo 12-Way	Micro Plug	1.5m	Absolute

6.1.4 90deg Tip – Bridge (IB Tech Inside) with plastic handle coding:

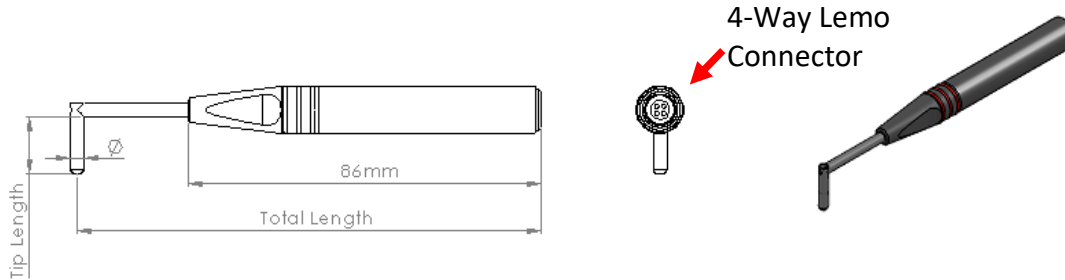

Standard

ETHer NDE Part No.	Centre Frequency	Tip Length (Total Length)	ØTip
Probe, Shielded, Plastic Handle, Right angled 90deg Tip:			
PS200PR050-114NB	200kHz	5.0 (MIN) Tip Length (Total Length 114mm, 4.5") (90deg Tip Shank)	4.45
PS200PR027-114FB	200kHz	2.7 (MIN) Tip Length (Total Length 114mm, 4.5") (90deg Tip Shank)	3.30 (Fine)
PS500PR050-114NB	500kHz	5.0 (MIN) Tip Length (Total Length 114mm, 4.5") (90deg Tip Shank)	4.45

PS500PR027-114FB	500kHz	2.7 (MIN) Tip Length (Total Length 114mm, 4.5") (90deg Tip Shank)	3.30 (Fine)
PS002PR027-114NB	2MHz	2.7 (MIN) Tip Length (Total Length 114mm, 4.5") (90deg Tip Shank)	3.30
PS002PR017-114FB	2MHz	1.7 (MIN) Tip Length (Total Length 114mm, 4.5") (90deg Tip Shank)	2.34 (Fine)
PS006PR017-114NB	6MHz	1.7 (MIN) Tip Length (Total Length 114mm, 4.5") (90deg Tip Shank)	2.34

Other variants available on request.

Leads to fit above probes:

ETHer NDE Part No.	Description	Connector Instrument End	Connector Probe End	Cable Length	Configuration
ALL12-L04-015B	Lead	Lemo 12-Way	Lemo 4-Way Plug	1.5m	Bridge

6.1.5 45deg Crank – Absolute with plastic handle coding:

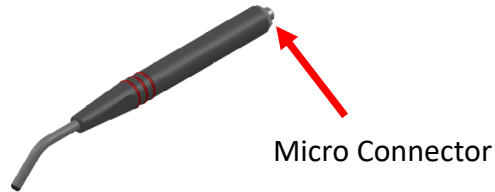
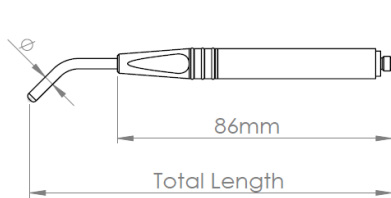

Standard

ETHer NDE Part No.	Centre Frequency	Tip Length (Total Length)	ØTip	Type
Probe, Shielded, Plastic Handle, Crank:				
PS200PC195-114N	200kHz	19.5 (0.75") Tip Length (Total Length 114mm, 4.5") (45deg Crank Shank)	4.45	Absolute
PS200PC195-114F	200kHz	19.5 (0.75") Tip Length (Total Length 114mm, 4.5") (45deg Crank Shank)	3.30 (Fine)	Absolute
PS500PC195-114N	500kHz	19.5 (0.75") Tip Length (Total Length 114mm, 4.5") (45deg Crank Shank)	4.45	Absolute
PS500PC195-114F	500kHz	19.5 (0.75") Tip Length (Total Length 114mm, 4.5") (45deg Crank Shank)	3.30 (Fine)	Absolute
PS002PC195-114N	2MHz	19.5 (0.75") Tip Length (Total Length 114mm, 4.5") (45deg Crank Shank)	3.30	Absolute

PS002PC195-114F	2MHz	19.5 (0.75") Tip Length (Total Length 114mm, 4.5") (45deg Crank Shank)	2.34 (Fine)	Absolute
PS006PC195-114N	6MHz	19.5 (0.75") Tip Length (Total Length 114mm, 4.5") (45deg Crank Shank)	2.34	Absolute

Other variants available on request.

Leads to fit above probes:

ETHer NDE Part No.	Description	Connector Instrument End	Connector Probe End	Cable Length	Configuration
ALLCX-M02-015A	Lead	Lemo Coaxial	Micro Plug	1.5m	Absolute
ALL12-M02-015A	Lead	Lemo 12-Way	Micro Plug	1.5m	Absolute

6.1.6 45deg Crank – Bridge (IB Tech Inside) with plastic handle coding:

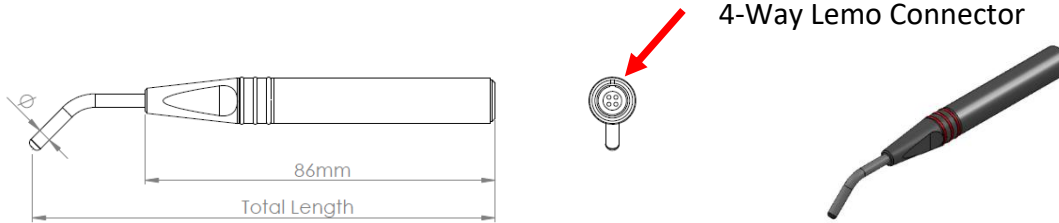

Standard

ETHER NDE Part No.	Centre Frequency	Tip Length (Total Length)	ØTip	Type
Probe, Shielded, Plastic Handle, Crank:				
PS200PC195-114NB	200kHz	19.5 (0.75") Tip Length (Total Length 114mm, 4.5") (45deg Crank Shank)	4.45	Bridge
PS200PC195-114FB	200kHz	19.5 (0.75") Tip Length (Total Length 114mm, 4.5") (45deg Crank Shank)	3.30 (Fine)	Bridge
PS500PC195-114NB	500kHz	19.5 (0.75") Tip Length (Total Length 114mm, 4.5") (45deg Crank Shank)	4.45	Bridge
PS500PC195-114FB	500kHz	19.5 (0.75") Tip Length (Total Length 114mm, 4.5") (45deg Crank Shank)	3.30 (Fine)	Bridge

PS002PC195-114NB	2MHz	19.5 (0.75") Tip Length (Total Length 114mm, 4.5") (45deg Crank Shank)	3.30	Bridge
PS002PC195-114FB	2MHz	19.5 (0.75") Tip Length (Total Length 114mm, 4.5") (45deg Crank Shank)	2.34 (Fine)	Bridge
PS006PC195-114NB	6MHz	19.5 (0.75") Tip Length (Total Length 114mm, 4.5") (45deg Crank Shank)	2.34	Bridge

Other variants available on request.

Leads to fit above probes:

ETHer NDE Part No.	Description	Connector Instrument End	Connector Probe End	Cable Length	Configuration
ALL12-L04-015B	Lead	Lemo 12-Way	Lemo 4-Way Plug	1.5m	Bridge

6.1.7 15deg Crank 90deg Tip – Absolute with plastic handle coding:

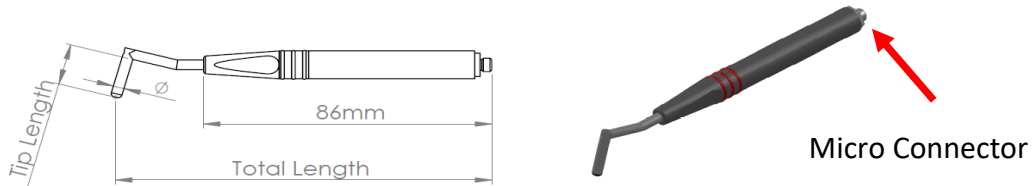

Standard

ETHer NDE Part No.	Centre Frequency	Tip Length (Total Length)	ØTip	Type
Probe, Shielded, Plastic Handle, Double crank				
PS200PD050-114N	200kHz	5.0 (MIN) Tip Length (Total Length 114mm, 4.5") (15deg Crank, 90deg tip Shank)	4.45	Absolute
PS200PD027-114F	200kHz	2.7 (MIN) Tip Length (Total Length 114mm, 4.5") (15deg Crank, 90deg tip Shank)	3.30 (Fine)	Absolute
PS500PD050-114N	500kHz	5.0 (MIN) Tip Length (Total Length 114mm, 4.5") (15deg Crank, 90deg tip Shank)	4.45	Absolute
PS500PD027-114F	500kHz	2.7 (MIN) Tip Length (Total Length 114mm, 4.5") (15deg Crank, 90deg tip Shank)	3.30 (Fine)	Absolute
PS002PD027-114N	2MHz	2.7 (MIN) Tip Length (Total Length 114mm, 4.5") (15deg Crank, 90deg tip Shank)	3.30	Absolute

PS002PD017-114F	2MHz	1.7 (MIN) Tip Length (Total Length 114mm, 4.5") (15deg Crank, 90deg tip Shank)	2.34 (Fine)	Absolute
PS006PD017-114N	6MHz	1.7 (MIN) Tip Length (Total Length 114mm, 4.5") (15deg Crank, 90deg tip Shank)	2.34	Absolute

Other variants available on request.

Leads to fit above probes:

ETHer NDE Part No.	Description	Connector Instrument End	Connector Probe End	Cable Length	Configuration
ALLCX-M02-015A	Lead	Lemo Coaxial	Micro Plug	1.5m	Absolute
ALL12-M02-015A	Lead	Lemo 12-Way	Micro Plug	1.5m	Absolute

6.1.8 15deg Crank 90deg Tip – Bridge (IB Tech Inside) with plastic handle coding:

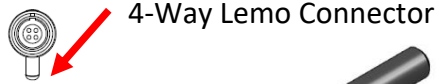
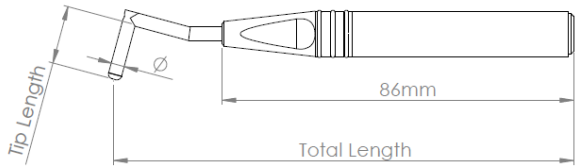

Standard

ETHer NDE Part No.	Centre Frequency	Tip Length (Total Length)	ØTip	Type
Probe, Shielded, Plastic Handle, Double crank				
PS200PD050-114NB	200kHz	5.0 (MIN) Tip Length (Total Length 114mm, 4.5") (15deg Crank, 90deg tip Shank)	4.45	Bridge
PS200PD027-114FB	200kHz	2.7 (MIN) Tip Length (Total Length 114mm, 4.5") (15deg Crank, 90deg tip Shank)	3.30 (Fine)	Bridge
PS500PD050-114NB	500kHz	5.0 (MIN) Tip Length (Total Length 114mm, 4.5") (15deg Crank, 90deg tip Shank)	4.45	Bridge
PS500PD027-114FB	500kHz	2.7 (MIN) Tip Length (Total Length 114mm, 4.5") (15deg Crank, 90deg tip Shank)	3.30 (Fine)	Bridge
PS002PD027-114NB	2MHz	2.7 (MIN) Tip Length (Total Length 114mm, 4.5") (15deg Crank, 90deg tip Shank)	3.30	Bridge

PS002PD017-114FB	2MHz	1.7 (MIN) Tip Length (Total Length 114mm, 4.5") (15deg Crank, 90deg tip Shank)	2.34 (Fine)	Bridge
PS006PD017-114NB	6MHz	1.7 (MIN) Tip Length (Total Length 114mm, 4.5") (15deg Crank, 90deg tip Shank)	2.34	Bridge

Other variants available on request.

Leads to fit above probes:

ETHer NDE Part No.	Description	Connector Instrument End	Connector Probe End	Cable Length	Configuration
ALL12-L04-015B	Lead	Lemo 12-Way	Lemo 4-Way Plug	1.5m	Bridge

6.2 Rotating Probes – Reflection

Rigid Stainless Steel

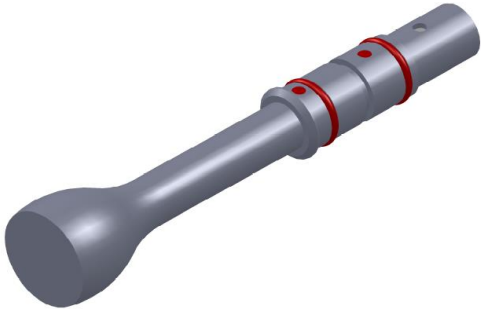

Delrin Flexible



Application:

Differential Rotating Probes - for internal diameter inspection of bore holes, countersinks and counter bores.

Specification:

- Probe diameters from 1.6 to 50mm, available in 0.01mm steps
- Fischer connector to ETher Small and Large drive also compatible with Hocking, GE, Rohmann and Forster drive units.
- Frequency range from 200kHz to 2MHz
- Comes in rigid stainless steel and delrin flexible options

Notes:

When ordering rotating probes 0.1mm is automatically taken off probe diameter during manufacture, this should be good for typical hole condition and manufacturing tolerances. Where tolerances are poor allow for greater clearance.

Example: To inspect a $\varnothing 12.7$ (1/2") hole a $\varnothing 12.7$ probe should be ordered which will be manufactured to a $\varnothing 12.6$.

6.2.1 Rigid Stainless-Steel Coding

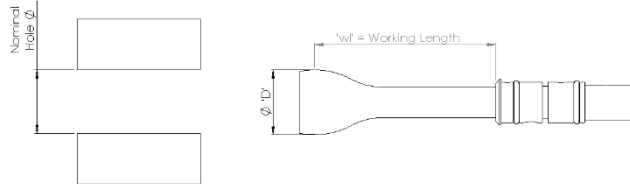

ETHer NDE Part No.	Description	Nominal Hole Dia "	Nominal Hole Dia mm	'wl' - Working Length mm
Imperial Examples:				
PRR0159-035	Probe. Rotating, Rigid, Dia = 1.59mm (1/16"), wl = 35mm	1/16"	1.59	35.0
PRR0198-035	Probe. Rotating, Rigid, Dia = 1.98mm (5/64"), wl = 35mm	5/64"	1.98	35.0
PRR0238-035	Probe. Rotating, Rigid, Dia = 2.38mm (3/32"), wl = 35mm	3/32"	2.38	35.0

ETHer NDE Part No.	Description	Nominal Hole Dia "	Nominal Hole Dia mm	'wl' - Working Length mm
PRR0278-035	Probe. Rotating, Rigid, Dia = 2.78mm (7/64"), wl = 35mm	7/64"	2.87	35.0
PRR0318-035	Probe. Rotating, Rigid, Dia = 3.18mm (1/8"), wl = 35mm	1/8"	3.18	35.0
PRR0357-035	Probe. Rotating, Rigid, Dia = 3.57mm (9/64"), wl = 35mm	9/64"	3.57	35.0
PRR0397-035	Probe. Rotating, Rigid, Dia = 3.97mm (5/32"), wl = 35mm	5/32"	3.97	35.0
PRR0437-035	Probe. Rotating, Rigid, Dia = 4.37mm (11/64"), wl = 35mm	11/64"	4.37	35.0
PRR0476-035	Probe. Rotating, Rigid, Dia = 4.76mm (3/16"), wl = 35mm	3/16"	4.76	35.0
PRR0516-035	Probe. Rotating, Rigid, Dia = 5.16mm (13/64"), wl = 35mm	13/64"	5.16	35.0
PRR0556-035	Probe. Rotating, Rigid, Dia = 5.56mm (7/32"), wl = 35mm	7/32"	5.56	35.0
PRR0595-035	Probe. Rotating, Rigid, Dia = 5.95mm (15/64"), wl = 35mm	15/64"	5.95	35.0
PRR0635-035	Probe. Rotating, Rigid, Dia = 6.35mm (1/4"), wl = 35mm	1/4"	6.35	35.0
PRR0675-035	Probe. Rotating, Rigid, Dia = 6.75mm (17/64"), wl = 35mm	17/64"	6.75	35.0
PRR0714-035	Probe. Rotating, Rigid, Dia = 7.14mm (9/32"), wl = 35mm	9/32"	7.14	35.0
PRR0754-035	Probe. Rotating, Rigid, Dia = 7.54mm (19/64"), wl = 35mm	19/64"	7.54	35.0
PRR0794-035	Probe. Rotating, Rigid, Dia = 7.94mm (5/16"), wl = 35mm	5/16"	7.94	35.0
PRR0833-035	Probe. Rotating, Rigid, Dia = 8.33mm (13/64"), wl = 35mm	21/64"	8.33	35.0
PRR0873-035	Probe. Rotating, Rigid, Dia = 8.73mm (11/32"), wl = 35mm	11/32"	8.73	35.0
PRR0913-035	Probe. Rotating, Rigid, Dia = 9.13mm (23/64"), wl = 35mm	23/64"	9.13	35.0
PRR0953-035	Probe. Rotating, Rigid, Dia = 9.53mm (3/8"), wl = 35mm	3/8"	9.53	35.0
PRR0992-035	Probe. Rotating, Rigid, Dia = 9.92mm (25/64"), wl = 35mm	25/64"	9.92	35.0
PRR1032-035	Probe. Rotating, Rigid, Dia = 10.32mm (13/32"), wl = 35mm	13/32"	10.32	35.0
PRR1072-035	Probe. Rotating, Rigid, Dia = 10.72mm (27/64"), wl = 35mm	27/64"	10.72	35.0

ETHer NDE Part No.	Description	Nominal Hole Dia "	Nominal Hole Dia mm	'wl' - Working Length mm
PRR1111-035	Probe. Rotating, Rigid, Dia = 11.11mm (7/16"), wl = 35mm	7/16"	11.11	35.0
PRR1151-035	Probe. Rotating, Rigid, Dia = 11.51mm (29/64"), wl = 35mm	29/64"	11.51	35.0
PRR1191-035	Probe. Rotating, Rigid, Dia = 11.91mm (15/32"), wl = 35mm	15/32"	11.91	35.0
PRR1230-035	Probe. Rotating, Rigid, Dia = 12.30mm (31/64"), wl = 35mm	31/64"	12.30	35.0
PRR1270-035	Probe. Rotating, Rigid, Dia = 12.70mm (1/2") wl = 35mm	1/2"	12.70	35.0
PRR1310-065	Probe. Rotating, Rigid, Dia = 13.10mm (33/64") wl = 65mm	33/64"	13.10	65.0
PRR1350-065	Probe. Rotating, Rigid, Dia = 13.50mm (17/32") wl = 65mm	17/32"	13.50	65.0
PRR1390-065	Probe. Rotating, Rigid, Dia = 13.90mm (35/64") wl = 65mm	35/64"	13.9	65.0
PRR1430-065	Probe. Rotating, Rigid, Dia = 14.30mm (9/16") wl = 65mm	9/16"	14.3	65.0
PRR1470-065	Probe. Rotating, Rigid, Dia = 14.70mm (37/64") wl = 65mm	37/64"	14.7	65.0
PRR1510-065	Probe. Rotating, Rigid, Dia = 15.10mm (19/32") wl = 65mm	19/32"	15.1	65.0
PRR1550-065	Probe. Rotating, Rigid, Dia = 15.50mm (39/64") wl = 65mm	39/64"	15.5	65.0
PRR1590-065	Probe. Rotating, Rigid, Dia = 15.90mm (5/8") wl = 65mm	5/8"	15.9	65.0
PRR1630-065	Probe. Rotating, Rigid, Dia = 16.30mm (41/64") wl = 65mm	41/64"	16.3	65.0
PRR1670-065	Probe. Rotating, Rigid, Dia = 16.70mm (21/32") wl = 65mm	21/32"	16.7	65.0
PRR1710-065	Probe. Rotating, Rigid, Dia = 17.10mm (43/64") wl = 65mm	43/64"	17.1	65.0
PRR1750-065	Probe. Rotating, Rigid, Dia = 17.50mm (11/16") wl = 65mm	11/16"	17.5	65.0
PRR1790-065	Probe. Rotating, Rigid, Dia = 17.90mm (45/64") wl = 65mm	45/64"	17.9	65.0
PRR1830-065	Probe. Rotating, Rigid, Dia = 18.30mm (23/32") wl = 65mm	23/32"	18.3	65.0
PRR1870-065	Probe. Rotating, Rigid, Dia = 18.70mm (47/64") wl = 65mm	47/64"	18.7	65.0
PRR1910-065	Probe. Rotating, Rigid, Dia = 19.10mm (3/4") wl = 65mm	3/4"	19.1	65.0

ETHer NDE Part No.	Description	Nominal Hole Dia "	Nominal Hole Dia mm	'wl' - Working Length mm
PRR1950-065	Probe. Rotating, Rigid, Dia = 19.50mm (49/64") wl = 65mm	49/64"	19.5	65.0
PRR1980-065	Probe. Rotating, Rigid, Dia = 19.80mm (25/32") wl = 65mm	25/32"	19.8	65.0
PRR2020-065	Probe. Rotating, Rigid, Dia = 20.20mm (51/64") wl = 65mm	51/64"	20.2	65.0
PRR2060-065	Probe. Rotating, Rigid, Dia = 20.60mm (13/16") wl = 65mm	13/16"	20.6	65.0
PRR2100-065	Probe. Rotating, Rigid, Dia = 21.00mm (53/64") wl = 65mm	53/64"	21.0	65.0
PRR2140-065	Probe. Rotating, Rigid, Dia = 20.20mm (27/32") wl = 65mm	27/32"	21.4	65.0
PRR2180-065	Probe. Rotating, Rigid, Dia = 20.20mm (55/64") wl = 65mm	55/64"	21.8	65.0
PRR2220-065	Probe. Rotating, Rigid, Dia = 20.20mm (7/8") wl = 65mm	7/8"	22.2	65.0
PRR2260-065	Probe. Rotating, Rigid, Dia = 20.20mm (57/64") wl = 65mm	57/64"	22.6	65.0
PRR2300-065	Probe. Rotating, Rigid, Dia = 20.20mm (29/32") wl = 65mm	29/32"	23.0	65.0
PRR2340-065	Probe. Rotating, Rigid, Dia = 20.20mm (59/64") wl = 65mm	59/64"	23.4	65.0
PRR2380-065	Probe. Rotating, Rigid, Dia = 20.20mm (15/16") wl = 65mm	15/16"	23.8	65.0
PRR2420-065	Probe. Rotating, Rigid, Dia = 20.20mm (61/64") wl = 65mm	61/64"	24.2	65.0
PRR2460-065	Probe. Rotating, Rigid, Dia = 20.20mm (31/32") wl = 65mm	31/32"	24.6	65.0
PRR2500-065	Probe. Rotating, Rigid, Dia = 20.20mm (63/64") wl = 65mm	63/64"	25.0	65.0
PRR2540-065	Probe. Rotating, Rigid, Dia = 20.20mm (1.0") wl = 65mm	1.0	25.4	65.0
Metric Examples:				
PRR0300-035	Probe. Rotating, Rigid, Dia = 3.00mm, wl = 35mm		3.00	35.0
PRR0400-035	Probe. Rotating, Rigid, Dia = 4.00mm, wl = 35mm		4.00	35.0
PRR0500-035	Probe. Rotating, Rigid, Dia = 5.00mm, wl = 35mm		5.00	35.0

ETHer NDE Part No.	Description	Nominal Hole Dia "	Nominal Hole Dia mm	'wl' - Working Length mm
PRR0600-035	Probe. Rotating, Rigid, Dia = 6.00mm, wl = 35mm		6.00	35.0
PRR0700-035	Probe. Rotating, Rigid, Dia = 7.00mm, wl = 35mm		7.00	35.0
PRR0800-035	Probe. Rotating, Rigid, Dia = 8.00mm, wl = 35mm		8.00	35.0
PRR0900-035	Probe. Rotating, Rigid, Dia = 9.00mm, wl = 35mm		9.00	35.0
PRR1000-035	Probe. Rotating, Rigid, Dia = 10.00mm, wl = 35mm		10.00	35.0
PRR1100-035	Probe. Rotating, Rigid, Dia = 11.00mm, wl = 35mm		11.00	35.0
PRR1200-035	Probe. Rotating, Rigid, Dia = 12.00mm, wl = 35mm		12.00	35.0
PRR1300-065	Probe. Rotating, Rigid, Dia = 13.00mm, wl = 65mm		13.00	65.0
PRR1400-065	Probe. Rotating, Rigid, Dia = 14.00mm, wl = 65mm		14.00	65.0
PRR1500-065	Probe. Rotating, Rigid, Dia = 15.00mm, wl = 65mm		15.00	65.0
PRR1600-065	Probe. Rotating, Rigid, Dia = 16.00mm, wl = 65mm		16.00	65.0
PRR1700-065	Probe. Rotating, Rigid, Dia = 17.00mm, wl = 65mm		17.00	65.0
PRR1800-065	Probe. Rotating, Rigid, Dia = 18.00mm, wl = 65mm		18.00	65.0
PRR1900-065	Probe. Rotating, Rigid, Dia = 19.00mm, wl = 65mm		19.00	65.0
PRR2000-065	Probe. Rotating, Rigid, Dia = 20.00mm, wl = 65mm		20.00	65.0
PRR2100-065	Probe. Rotating, Rigid, Dia = 21.00mm, wl = 65mm		21.00	65.0
PRR2200-065	Probe. Rotating, Rigid, Dia = 22.00mm, wl = 65mm		22.00	65.0
PRR2300-065	Probe. Rotating, Rigid, Dia = 23.00mm, wl = 65mm		23.00	65.0
PRR2400-065	Probe. Rotating, Rigid, Dia = 24.00mm, wl = 65mm		24.00	65.0
PRR2500-065	Probe. Rotating, Rigid, Dia = 25.00mm, wl = 65mm		25.00	65.0

6.2.2 Delrin Flexible Coding

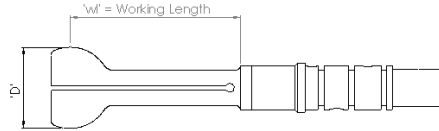

ETHer NDE Part No.	Description	Hole Dia Range mm	Nominal Diameter	'wl' - Working Length mm
Examples:				
PRF040-050051	Probe. Rotating, Flexible, Dia = 4.0 – 5.0mm, wl = 51.00mm	4.0-5.0	3/16" (4.76mm)	51
PRF050-060051	Probe. Rotating, Flexible, Dia = 5.0 – 6.0mm, wl = 51.00mm	5.0-6.0	7/32" (5.56mm)	51
PRF060-070051	Probe. Rotating, Flexible, Dia = 6.0 – 7.0mm wl = 51.00mm	6.0-7.0	1/4" (6.35mm)	51
PRF070-080051	Probe. Rotating, Flexible, Dia = 7.0 – 8.0mm wl = 51.00mm	7.0-8.0	5/16" (7.94mm)	51
PRF080-090051	Probe. Rotating, Flexible, Dia = 8.0 – 9.0mm wl = 51.00mm	8.0-9.0	21/64" (8.33mm)	51
PRF090-100051	Probe. Rotating, Flexible, Dia = 9.0 – 10.0mm wl = 51.00mm	9.0-10.00	3/8" (9.53mm)	51
PRF100-110051	Probe. Rotating, Flexible, Dia = 10.0 – 11.0mm wl = 51.00mm	10.0-11.00	13/32" (10.32mm)	51
PRF110-120051	Probe. Rotating, Flexible, Dia = 11.0 – 12.0mm wl = 51.00mm	11.0-12.00	7/16" (11.11mm)	51
PRF120-130051	Probe. Rotating, Flexible, Dia = 12.0 – 13.0mm wl = 51.00mm	12.00-13.00	1/2" (12.70mm)	51
PRF130-150051	Probe. Rotating, Flexible, Dia = 13.0 – 15.0mm wl = 51.00mm	13.00 - 15.00	9/16" (14.30mm)	51
PRF150-170051	Probe. Rotating, Flexible, Dia = 15.0 – 17.0mm wl = 51.00mm	15.00 - 17.00	5/8" (15.90mm)	51

ETHer NDE Part No.	Description	Hole Dia Range mm	Nominal Diameter	'wl' - Working Length mm
PRF170-190051	Probe. Rotating, Flexible, Dia = 17.0 – 19.0mm wl = 51.00mm	17.00 - 19.00	11/16" (17.50mm)	51
PRF190-210051	Probe. Rotating, Flexible, Dia = 19.0 – 21.0mm wl = 51.00mm	19.00 - 21.00	3/4" (19.10mm)	51
PRF210-230051	Probe. Rotating, Flexible, Dia = 21.0 – 23.0mm wl = 51.00mm	21.00 - 23.00	7/8" (22.00mm)	51
PRF230-250051	Probe. Rotating, Flexible, Dia = 23.0 – 25.0mm wl = 51.00mm	23.00 - 25.00	15/16" (23.80mm)	51
PRF250-270051	Probe. Rotating, Flexible, Dia = 25.0 – 27.0mm wl = 51.00mm	25.00 - 27.00	1" (25.40mm)	51
PRF270-290051	Probe. Rotating, Flexible, Dia = 27.0 – 29.0mm wl = 51.00mm	27.00 - 29.00	1 1/8" (28.57mm)	51
PRF290-310051	Probe. Rotating, Flexible, Dia = 29.0 – 31.0mm wl = 51.00mm	29.00 - 31.00	1 3/16" (30.17mm)	51
PRF310-330051	Probe. Rotating, Flexible, Dia = 31.0 – 33.0mm wl = 51.00mm	31.00 - 33.00	1 1/4" (31.75mm)	51
PRF330-350051	Probe. Rotating, Flexible, Dia = 33.0 – 35.0mm wl = 51.00mm	33.00 - 35.00	1 3/8" (34.93mm)	51
PRF350-370051	Probe. Rotating, Flexible, Dia = 35.0 – 37.0mm wl = 51.00mm	35.00 - 37.00	1 7/16" (36.51mm)	51
PRF370-390051	Probe. Rotating, Flexible, Dia = 37.0 – 39.0mm wl = 51.00mm	37.00 - 39.00	1 1/2" (38.10mm)	51
Other options available on request.				

6.3 Manual Bolt Hole Probes – Absolute

Manual Bolt Hole – Dia 3.2 to 11mm

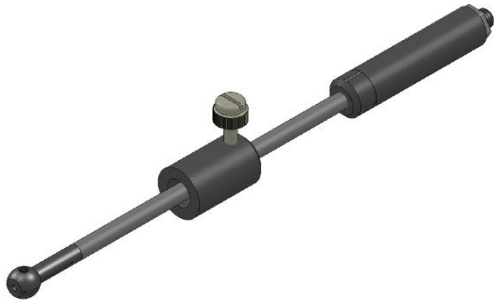

Manual Bolt Hole – Dia 11.5 to 38mm



Application:

For manual internal diameter inspection of bore holes.

Specification:

- All probes have a Delrin Tip
- Connector – Micro for absolute
- Centre frequency/Operating range – 200kHz (50kHz – 600kHz), 500kHz (150kHz – 1.5MHz), 2MHz – (650kHz – 6MHz)

Example: **PB200R070-080**

Probe, Manual Bolt Hole	Centre Frequency	Shank	Tip Diameter or Range (mm) WL= (mm)	Nominal Diameter
PB	200	R	070-080	
	200 = 200kHz	Rigid	032 - Dia = 3.2, WL = 76mm	1/8"
	500 = 500kHz		036 - Dia = 3.6, WL = 76mm	9/64"
	002 = 2MHz		039 - Dia = 3.9, WL = 76mm	5/32"
			043 - Dia = 4.3, WL = 76mm	11/64"
			045-055 - Dia = 4.5 - 5.5, WL = 76mm	3/16"
			055-065 - Dia = 5.5 - 6.5, WL = 76mm	7/32"
			060-070 - Dia = 6.0 - 7.0, WL = 76mm	1/4"
			070-080 - Dia = 7.0 - 8.0, WL = 76mm	9/32"
			075-090 - Dia = 7.5 - 9.0, WL = 76mm	5/16"
			085-100 - Dia = 8.5 - 10.0, WL = 76mm	11/32"
			095-110 - Dia = 9.5 - 11.0, WL = 76mm	3/8"
			100-115 - Dia = 10.0 - 11.5, WL = 76mm	13/32"
			110-125 - Dia = 11.0 - 12.5, WL = 76mm	7/16"
			115-130 - Dia = 11.5 - 13.0, WL = 76mm	15/32"
			125-140 - Dia = 12.5 - 14.0, WL = 76mm	1/2"

			130-145 – Dia = 13.0 – 14.5, WL = 76mm	17/32"
			140-155 – Dia = 14.0 – 15.5, WL = 76mm	9/16"
			150-165 – Dia = 15.0 – 16.5, WL = 76mm	19/32"
			155-170 – Dia = 15.5 – 17.0, WL = 76mm	5/8"
			165-180 – Dia = 16.5 – 18.0, WL = 76mm	21/32"
			170-185 – Dia = 17.0 – 18.5, WL = 76mm	11/16"
			180-195 – Dia = 18.0 – 19.5, WL = 76mm	23/32"
			190-205 – Dia = 19.0 – 20.5, WL = 76mm	3/14"
			195-210 – Dia = 19.5 – 21.0, WL = 76mm	25/32"
			205-220 – Dia = 20.5 – 22.0, WL = 76mm	13/16"
			210-225 – Dia = 21.0 - 22.5, WL = 76mm	27/32"
			220-235 – Dia = 22.0 - 23.5, WL = 76mm	7/8"
			230-245 – Dia = 23.0 - 24.5, WL = 76mm	29/32"
			235-250 – Dia = 23.5 – 25.0, WL = 76mm	15/16"
			245-260 – Dia = 24.5 – 26.0, WL = 76mm	31/32"
			250-265 – Dia = 25.0 – 26.5, WL = 76mm	1"
			260-275 – Dia = 26.0 – 27.5, WL = 76mm	33/32"
			265-280 – Dia = 26.5 -28.0, WL = 76mm	17/16"
			275-290 – Dia = 27.5 – 29.0, WL = 76mm	35/32"
			285-300 – Dia = 28.5 -30.0, WL = 76mm	9/8"

			290-305 – Dia = 29.0 – 30.5, WL = 76mm	37/32"
			300-315 – Dia = 30.0 – 31.5, WL = 76mm	19/16"
			305-320 – Dia = 30.5 – 32.0, WL = 76mm	39/32"
			315-330 – Dia = 31.5 – 33.0, WL = 76mm	5/4"
			325-340 – Dia = 32.5 – 34.0, WL = 76mm	41/32"
			330-345 – Dia = 33.0 – 34.5, WL = 76mm	21/16"
			340-355 – Dia = 34.0 – 35.5, WL = 76mm	43/32"
			345-360 – Dia = 34.5 – 36.0, WL = 76mm	11/8"
			355-370 – Dia = 35.5 – 37.0, WL = 76mm	45/32"
			365-380 – Dia = 36.5 – 38.0, WL = 76mm	23/16"
			370-385 – Dia = 37.0 – 38.5, WL = 76mm	47/32"
			380-395 – Dia = 38.0 - 39.5, WL = 76mm	1.5"

Other variants available on request.

Leads to fit above probes:

ETHer NDE Part No.	Description	Connector Instrument End	Connector Probe End	Cable Length	Configuration
ALLCX-M02-015A	Lead	Lemo OO Coaxial	Micro Plug	1.5m	Absolute
ALL12-M02-015A	Lead	Lemo 12-Way Plug	Micro Plug	1.5m	Absolute

6.4 Spot Face Low Frequency Probes



Application:

Reflection sub surface probes - for general purpose inspection of sub-surface corrosion and flaws. This probe has excellent depth penetration making it ideal for multi-layer inspections.

Specification:

- Broad frequency ranges
- Excellent low frequency performance
- Integrated 4-way Lemo connector
- Built in balance coils
- Right angled probes are intrinsically balanced

Notes:

The lower the frequency the deeper the depth of penetration.

STANDARD DEPTH OF PENETRATION

$$\delta = \frac{1}{\sqrt{2\pi f \mu \sigma}}$$

δ = standard depth of penetration in metres (m) or skin depth.
 π = pi (3.1415)

f = frequency (Hz)

μ = Magnetic Permeability (Henries per meter). As =1 for non-ferrous material
 then = $4 * 10^{-7} = 1.257 * 10^{-6}$

σ = Conductivity (Siemens/metre)

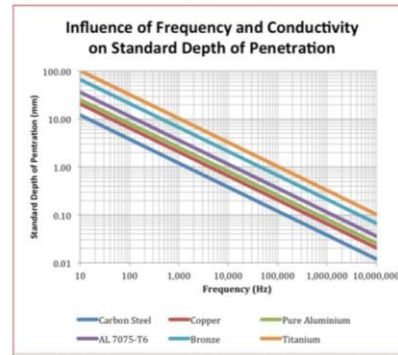

DEPTH OF PENETRATION AND PROBE SIZE

Smith et al have introduced the idea of spatial frequency.

$$\delta = \frac{1}{\sqrt{\frac{4^2}{D^2} + 2\pi f \mu \sigma}}$$

Where D = the effective diameter of the probe field in metres. This limits the depth of penetration to D/4. In the usual equation the probe effective diameter is assumed to be infinite.

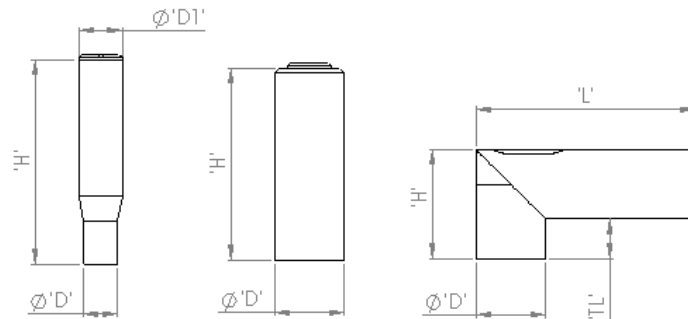

	'D' mm	'D1' mm	'H' mm	'L' mm	'TL' mm
Straight					
PUS07	7	10	47		
PUS08	8	10	47		
PUS11	11		44		
PUS13	13		44		
PUS16	16		44		
PUS24	24		57		
PUS32	32		59		
Right Angled					
PUR11	11		22.6	50	11.5
PUR13	13		21.5	50	8.15
PUR16	16		25	50	9.11
PUR24	24		33.80	58	10.10

Probe Coding:

ETHer NDE Part No.	Description	Ø	Body Material	Frequency Range	Connector
Probe, Surface, Straight					
PUS07	Probe, Surface, Straight,	7mm	St Steel	1kHz – 100kHz	Lemo 4-Way
PUS08	Probe, Surface, Straight,	8mm	St Steel	1kHz – 100kHz	Lemo 4-Way
PUS11	Probe, Surface, Straight,	11mm	Acetal	300Hz – 100KHz	Lemo 4-Way
PUS13	Probe, Surface, Straight,	13mm	Acetal	200Hz – 200KHz	Lemo 4-Way
PUS16	Probe, Surface, Straight,	16mm	Acetal	300Hz – 100kHz	Lemo 4-Way
PUS24	Probe, Surface, Straight,	24mm	Acetal	80Hz – 60KHz	Lemo 4-Way
PUS32	Probe, Surface, Straight,	32mm	Acetal	80Hz – 60KHz	Lemo 4-Way

ETHer NDE Part No.	Description	Ø	Body Material	Frequency Range	Connector
Probe, Surface, Right Angled					
PUR11	Probe, Surface, Right Angled,	11mm	Acetal	300Hz – 200KHz	Lemo 4-Way
PUR13	Probe, Surface, Right Angled,	13mm	Acetal	200Hz – 200KHz	Lemo 4-Way
PUR16	Probe, Surface, Right Angled,	16mm	Acetal	300Hz – 100kHz	Lemo 4-Way
PUR24	Probe, Surface, Right Angled,	24mm	Acetal	80Hz – 60KHz	Lemo 4-Way

Leads to fit above probes:

ETHer NDE Part No.	Description	Connector Instrument End	Connector Probe End	Cable Length	Configuration
ALL12-L04-015R	Lead	Lemo 12-Way	Lemo 4-Way	1.5m	Reflection

6.5 Sliding Probes – Dual Element

PFS001 - Dual element sliding probe

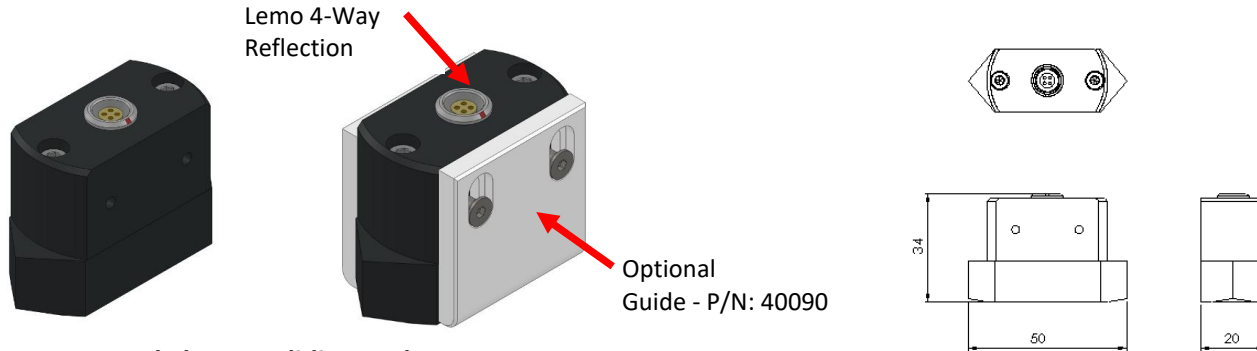

PFS002 - Dual element sliding probe

X2 Micro Connectors



Application:

Typically used on aircraft wings (and on other similar structures) to detect cracks and corrosion on or near the surface around fasteners and in deeper layers under the skins. The above probes either slide along or over rows of fasteners.

Probe Coding:

PFS001 - Dual element sliding probe - Reflection - Lemo 4-Way - contains a transmit and receive element - 400Hz-50kHz - used on fastener head sizes 1mm and below.

PFS002 - Dual element sliding probe - Tx, Rx - contains a transmit and receive element - 100Hz-500kHz - Comes with 1.5, 2.5 and 3.5mm wide Lens.

Leads to fit above probes:

ETHER NDE Part No.	Description	Connector Instrument End	Connector Probe End	Cable Length	Configuration
ALL12-L04-015R	Lead	Lemo 12-Way	Lemo 4-Way	1.5m	Reflection
ALL12-M02-M02-015AR	Lead	Lemo 12-Way	X2 micro Plug	1.5m	Transmit & Receive

6.6 Low Frequency Fastener Inspection Probes

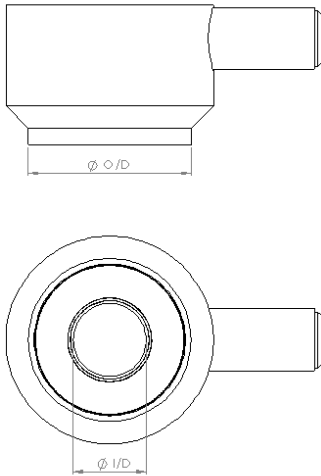

Application:

Typically used on aircraft wings (and on other similar structures) to detect cracks and corrosion around fasteners without requiring removal of the fastener.

Probe Coding:

ETHer NDE Part No.	Frequency Range	I/D Diameter	Description
PD0516	250Hz-40kHz	5	Probe, Ring, (Donut) 250Hz - 40kHz, I/D 5mm O/D 16mm
PD0619	500Hz - 40kHz	6	Probe, Ring, (Donut) 500Hz - 40kHz, I/D 6mm O/D 19mm
PD06719	250Hz-40kHz	6.7	Probe, Ring, (Donut) 250Hz - 40kHz, I/D 6.7mm O/D 19mm
PD0822	250Hz-40kHz	8	Probe, Ring, (Donut) 250Hz - 40kHz, I/D 8mm O/D 22mm
PD08419	250Hz-40kHz	8.4	Probe, Ring, (Donut) 250Hz - 40kHz, I/D 8.4mm O/D 19mm
PD0922	250Hz-40kHz	9	Probe, Ring, (Donut) 250Hz - 40kHz, I/D 09mm O/D 22mm
PD09719	250Hz-40kHz	9.7	Probe, Ring, (Donut) 250Hz - 40kHz, I/D 9.7mm O/D 19mm
PD1022	250Hz-40kHz	10	Probe, Ring, (Donut) 250Hz - 40kHz, I/D 10mm O/D 22mm
PD1122	250Hz-40kHz	11	Probe, Ring, (Donut) 250Hz - 40kHz, I/D 11mm O/D 22mm
PD1225	80Hz-50kHz	12	Probe, Ring, (Donut) 80Hz - 50kHz, I/D 12mm O/D 25mm
PD1329	80Hz-50kHz	13	Probe, Ring, (Donut) 80Hz - 50kHz, I/D 13mm O/D 29mm
PD1332	80Hz-50kHz	13	Probe, Ring, (Donut) 80Hz - 50kHz, I/D 13mm O/D 32mm
PD1429	80Hz-50kHz	14	Probe, Ring, (Donut) 80Hz - 50kHz, I/D 14mm O/D 29mm
PD1531	80Hz-50kHz	15	Probe, Ring, (Donut) 80Hz - 50kHz, I/D 15mm O/D 31mm
PD1629	80Hz-50kHz	16	Probe, Ring, (Donut) 80Hz - 50kHz, I/D 16mm O/D 29mm
PD1640	80Hz-50kHz	16	Probe, Ring, (Donut) 80Hz - 50kHz, I/D 16mm O/D 40mm
PD2038	80Hz-50kHz	20	Probe, Ring, (Donut) 80Hz - 50kHz, I/D 20mm O/D 38mm
PD2844	80Hz-50kHz	28	Probe, Ring, (Donut) 80Hz - 50kHz, I/D 28mm O/D 52mm

Leads to fit above probes:

ETHer NDE Part No.	Description	Connector Instrument End	Connector Probe End	Cable Length	Configuration
ALL12-L04-015R	Lead	Lemo 12-Way	Lemo 4-Way	1.5m	Reflection

7 Connectors

Connector 1

Instrument: LEMO 12-Way Panel Mounted: HGG.2B.312.CLLP

Mating Connector: LEMO Plug 12-Way Free FGG.2B.312.CLAD.52Z

Pin	Name	Description
1	FG0V	Generator 0v
2	FGO/P	Generator output
3	+VB	Battery Supply
4	Motor –	Motor drive current return.
5	Motor +	Motor drive current feed.
6	OVD	Electrical ground (analogue).
7	Diff+	Pick-up signal terminal. Positive.
8	Diff–	Pick-up signal terminal. Negative.
9	ENC	Encoder signal from rotating probe, one tick per turn.
10	Gunsw/sck	Dual Use Gun Switch On/Off and also I2C bus clock
11	Gun sda	GUN I2C bus data
12	Gunalarm	Output of instrument flaw alarm

Using the Voltage free alarm contact; there is a V-MOS FET connected between pin 6 (OVD) and 12 (Gunalarm). You will need to pull up pin 12 to a Power Supply (e.g., but not necessarily pin 3 (+VB)) with say a 10k resistor. You can also use an external supply but must make sure that its 0v is connected to Pin 6. **Note:** the maximum rating for the Transistor is 50v dc at 10mA.

Connector 2 (Lemo Coaxial)

Instrument: LEMO OO Panel Mounted: HGP.00.250.CLLP

Mating Connector: LEMO Plug OO: PCA.00.250.CTLC29Z

Pin	Name	Description
1	0V	Ground (electrical connected to mechanical)
2	SIGNAL	Bridge signal

Connector 3 (Power)

Instrument: LEMO 2-Way Panel Mounted Hermaphroditic Keying (Half Moon Inset): HGP.0S.302.CLLP

Mating Connector: Lemo 2-Way Hermaphroditic Keying (Half Moon Inset): FFA.0S.302.CLAC37Z

8 Software Update and System Recovery

8.1 Updating AeroCheck3 software

1. To update the AeroCheck3 software, the new file must be present on the micro-SD Card in the instrument; this is accessible under the flap on the side of the instrument. The file is in the format EtherCheckv0000.hex.
2. There are 2 methods of getting the file on to the micro-SD Card:
 - 1 Remove the card and place it in a micro-SD Card Reader connected to a PC. Then use the PC to copy the file on to the card. The file **MUST** be in the **\EtherCheck** directory!!
 - 2 Use the PC package ETHERRealtime that is available from ETHERNDE for controlling and communicating with an AeroCheck3. See the section below on using ETHERRealtime to copy the file on to the micro-SD card, again, ensuring that it is in the **\EtherCheck** directory.
3. Now that the file is present on the card and in the **\EtherCheck** directory:
 - Power OFF the AeroCheck3.
 - Hold the LEFT key and turn the AeroCheck3 ON using the POWER key. This will start the Boot Loader software and the screen will display “Searching for files...”
 - Below this, a list of compatible files in the \EtherCheck directory will be displayed. If there are more than 1, the UP and DOWN arrows will move the highlight. Once the desired file is highlighted, press Enter.
 - First, the AeroCheck3 will erase the existing software from the flash, this will take approx. 10 seconds.
 - Now the new version will be installed. Its progress in percent is shown. It will take approx. 1.5 minutes.
 - When instructed to Reboot, hold the power key until the screen goes BLACK, this will take approx. 10s. Now release the key.

- Installation is now complete and the instrument can be used as normal. If there was a problem during installation the AeroCheck3 may be unusable as an Eddy Current Instrument until a successful installation has occurred. If this was due to a corrupt version of the firmware on the micro Card (this is the usual cause) then a valid version will need to be copied on to the card, see removing the micro Card in 2) above.

8.2 Default Mode

In the Load Save Menu there is a DEFAULT setting that cannot be altered by the user. Use this to put the instrument into a pre-defined state.

8.3 ETHERRealtime PC Package Note: Always check with ETHERNDE for current ETHERRealtime version.

To connect to the AeroCheck3 from a PC, the **ETHERRealtime** package must be used. This package is freely available from ETHERNDE and is present on the supplied USB Memory Stick, or downloadable from our Website.

ETHERRealtime PC allows remote control of the AeroCheck3 instrument, displays real-time values from the instrument and allows files (Settings, Screenshots and Software Update files) to be taken from and loaded on to the instrument micro SD Card. **ETHERRealtime** PC main screen:

Description of components:

1. 11-key Keypad. This is the same as the keypad on the instrument. Clicking on a key here has the same effect as pressing the real key on the instrument, with the exception of the Power Enter key.
2. ALARM indicator. If the instrument has an alarm configured this button will glow RED in sync with that of the instrument.
3. Progress Bar. If a file transfer is in progress, this bar shows the progress.

4. 8 Tabs offering different information on the connected instrument, Connection, Data Logging, File System, Phase Plane, Settings, Data Files. See below for a description of each.

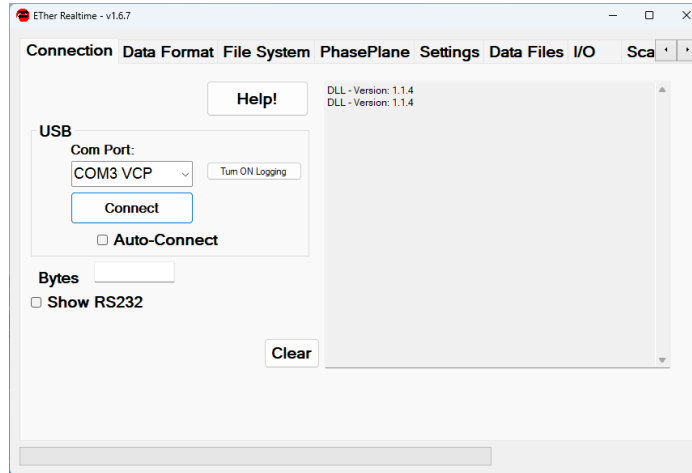

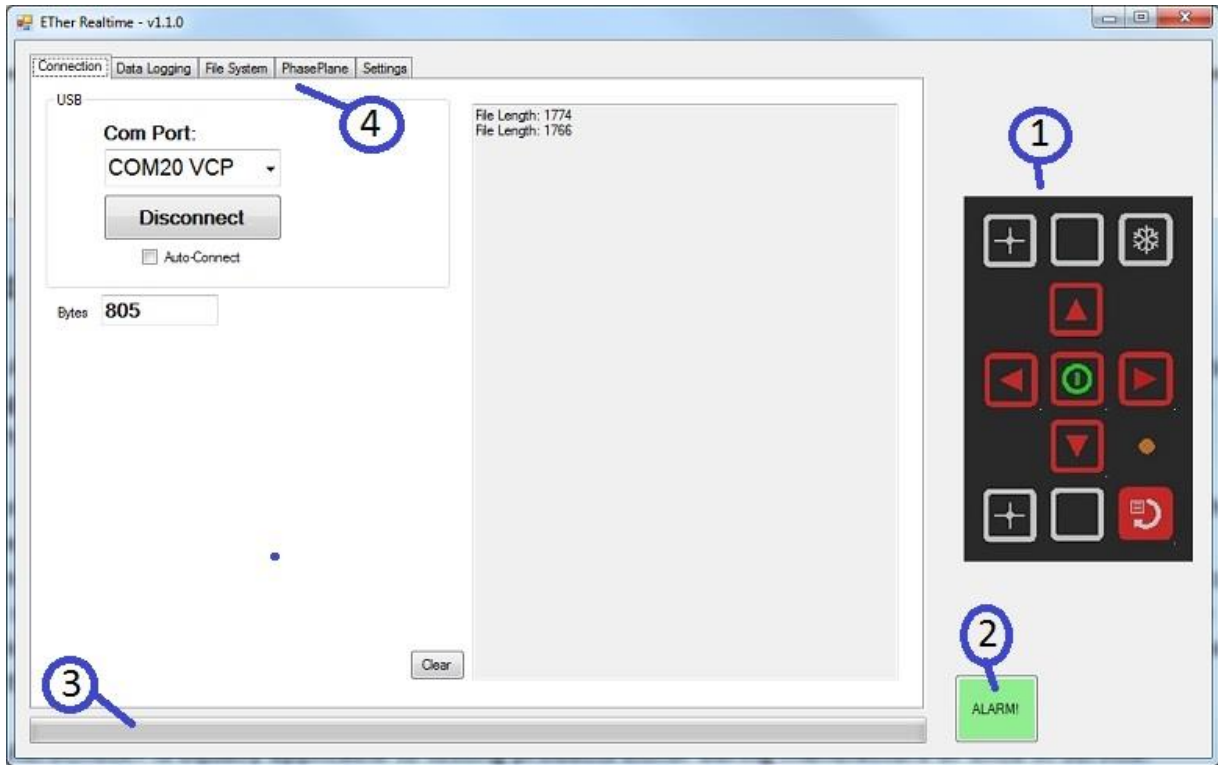

8.3.1 ETherCheck Tabs

8.3.2 Connection

When an AeroCheck3 is connected to the PC via USB its COM port will automatically be displayed in the drop down. Click **Connect** to connect to the instrument or check Auto-Connect to do exactly that when an instrument is plugged in.

8.3.3 Data Logging

The 6 radio buttons select what sort of data is to be transmitted by the instrument:

- Conductivity – Only use when the instrument is in Conductivity Mode. The Conductivity and Lift-Off are shown, along with the other technical values of Radius and Theta.
- Non-Realtime – The values of X & Y for channel 1, 2 & Mix and Radius & Theta of Channel 1 are shown. The data rate is slower and not suitable for automated systems but more than sufficient for use by a person.
- Single Channel Post – This is post-processed data that has been offset to show actual screen coordinates. This setting must be used for the Phase Plane tab to show data.
- Post Process – This shows real-time post processed data for Channels 1, 2 & Mix.
- Raw – Raw Eddy Current data from the probe for channels 1 & 2.
- None – Shows nothing.

8.3.4 File System

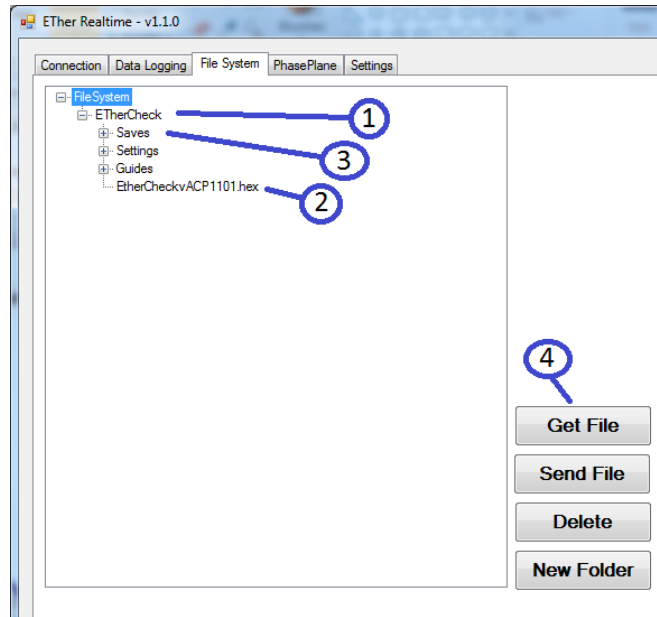

When an AeroCheck3 is connected to CheckPC and the **File System** Tab is selected **ETHERRealtime** will download the file system that is present on the micro-SD card, accessible under the flap. The file system is displayed in a window. Each folder can be expanded or collapsed by clicking on the + or – symbol. An example screen shot is shown below:

Description of components:

1. This is a Folder. It can be expanded and collapsed using the + and – icon to the left of the text.
2. This is a Software update file (ends in .hex). These **MUST** be in the Ether Check folder to be recognised by the Boot Loader.
3. In the Saves folder are the Settings folders and files that are used by the instrument. Several are present by default on a new machine. Users create others. They can be retrieved or sent to an AeroCheck3 (see below).
4. File action buttons: Delete (File or Folder), Get File, Send File and New Folder. These buttons are only available once a file or folder is highlighted. See below for detailed explanation of their use.

- a. Deleting a File (or Folder)

If a File or Folder is highlighted, clicking on **Delete File** will delete the specified file. BE VERY CAREFUL when doing this, deleted files cannot be undeleted afterwards. A folder **MUST** be empty before it can be deleted.

- b. Get File (getting a file FROM the AeroCheck3):

Click on a file so that it is highlighted. Click on **Get File**. The file will upload to the PC; its progress will be shown on the progress bar on the main screen. Once complete, a file save dialog window will appear. Use this to choose a location and filename of the uploaded file.

- c. Send File (Sending a file FROM the PC to the Weld Check) :

Click on a folder (or file within a folder) that will receive the file. Click on Send File. A File Open dialog window will appear, find and choose the file to send TO the AeroCheck3. Click Enter. The file will begin downloading; its progress will be shown on the progress bar on the main screen. Once complete, the File System window will refresh and the new file should be visible.

- d. New Folder.

With an existing folder highlighted, click on this button to create a new folder within the highlighted one. A new window will appear requesting the name of the new folder to be created.

8.3.5 Phase Plane

This tab attempts to mimic the real time display of the instrument. For this to work the ***Single Channel Post*** button must be selected on the previous Tab.

8.3.6 Settings

This displays a full set of the instruments settings that it is currently using. Please note, these values are not all human readable but are what the instrument requires should commands need to be sent by automated equipment.

9 Specification

Probe	Connectors	12-Way Lemo 2B (IP68) (Absolute, Bridge, Reflection and Rotary) and Connection Lemo 00 (IP68) (for single element absolute probes). Simultaneous probe operation possible using Lemo 12-Way and Lemo 00. Conductivity option becomes active with use of conductivity probe and cable.
	Rotary Drive	600-3000 rpm - ETHER Mercury Drive (ADR002), Hocking 33A100, Rohmann MR3, SR1 and SR2 Drive (special adapter needed)
	Conductivity	Option becomes active with use of AeroCheck conductivity probe and cable, see spec at end of table.
Frequency	Single/Dual	10Hz to 20 MHz
Gain	Overall	-18 to + 104 dB, 0.1, 1 and 6dB steps
	Input	0dB or 12dB
	Drive	-6, -5, -4, -3, -2, -1, 0, 1, 2, 3, 4, 5, 6, 7, 8, 9, 10dB (0dB reference 1mW into 50 ohm)
	Max X/Y Ratio	+/-100.0 dB
Phase	Range	0.0-359.9°, 0.1° steps
	Auto Phase	Allows phase angle to be automatically set to a pre-set angle
Filters	High Pass	DC to 2kHz or Low Pass Filter, whichever is the lower in 1 Hz steps. Plus variable adaptive balance drift compensation 0.01 - 0.5 Hz (6 steps).
	Low Pass	1Hz to 2KHz or a quarter of the lowest test frequency whichever is lower in 1 Hz steps.
Balance Load	Manual	14 internal balance loads; 2.2μH, 5.0μH, 6.0μH, 6.5μH, 7.0μH, 7.5μH, 8.2μH, 12μH, 15μH, 18μH, 22μH, 30μH, 47μH, 82μH,
	Automatic	Optimised balance load selection.
Mix Channel	Frequency	Full frequency range available on both channels

	Probe Mode	Simultaneous reflection / bridge and absolute including simultaneous two probe Differential and Absolute
	Mix Gain	X/Y -18 to +18dB
	Mix Phase	0.0-359.9°, 0.1° steps
Alarms Gates	Box	Fully configurable, Freeze, Tone or visual.
	Sector	Fully configurable, Freeze, Tone or visual.
	Output	Open collector transistor (50v dc at 10mA max) available on 12-way Lemo
Display	Type	5.7" (145mm), 18-bit Colour, daylight readable.
	Viewable Area	115.2mm (Horizontal) x 86.4mm (Vertical)
	Resolution	640 x 480 pixels
	Flip	Manual screen orientation change to enable left or right handed use.
	Colour Schemes	User configurable Dark, Bright and Black & White
	Configurable Screen	Full Screen, Single, Dual Spot or Dual Pane with variable size and location and function e.g. XY, Time base, Waterfall and Meter.
	Display Modes	Spot, Time base (0.1-20 seconds x 1-200 sweeps and up to 55 seconds), Waterfall and Meter with peak hold and % readout.
	Graticules	None, Grid (4 sizes 5, 10,15 and 20% FSH), Polar (4 sizes 5, 10,15 and 20% FSH)
	Offset	Spot Position: Y =-50 to +50, X =-65 to +65%
	Digital Spot Position Readout	Display in X,Y or R,θ
	Summary	Display/Edit of all settings in Legacy Format

Removable Data Storage	Setup Storage	microSDHC up to 32GB, holding over 10,000 settings
	Stored Screen Shots	micro-SD up to 32GB, holding over 10,000 screen shots
	Guides	micro-SD up to 32GB, holding 10,000 Slides
	Recorded Data	micro-SD up to 32GB, holding over 500 2.5 minute long data recordings
	Record Replay	Real-time recording of trace data and Replay on instruments and desktop PC up to 164 seconds
Advanced Features	Data logging	Real-time recording of signal data and Replay on instruments and desktop PC up to 164 seconds
	Guides	Create and display a slide show containing instructions, tutorials and procedures using Microsoft PowerPoint.
	Attachments	Screenshots and Data Recordings are saved in a folder with the name of the Settings.
	Loop	Capture a live repetitive signal and then optimise the instrument settings (Phase, Gain, Filters) to simplify optimising the parameters
	Trace	Allows a calibration reference signal to be stored on the screen and then compared with the live signal
	Auto Phase	Allows phase angle to be automatically set to a preset angle
Outputs	PC Connectivity	USB (Full PC remote control plus Real Time data)
	Digital volt free Alarm	On Lemo 12-way Open collector transistor (36v dc at 10mA max).
	VGA	Full 15-way VGA output (EC screens only)

Languages		English, French, Spanish, Russian, Japanese, Chinese, Turkish.
Verification Level		The system includes on delivery a 2 year validity Verification Level 2 detailed functional check and calibration as per ISO 15548-1:2013
Power on self test		The system performs a self-test on start up of external ram, sd ram, accelerometer, Micro SD card, and LCD screen buffer.
Power	External	100-240 v 50-60Hz 30 Watts
	Battery	Internal 7.2V nominal @ 3100mAh = 22.32 watt.hr
	Running Time	Up to 8 hours with a 2MHz Pencil Probe 30% Back Light
	Charging Time	2.5 hrs. charge time, Simultaneous charge, and operation
	Connector	Lemo OS Hermaphroditic keying, half-moon inset (IP68)
Physical	Weight Including Internal Battery	1.15 kg, 2.54 lbs.
	Size (w x h x d)	222.2mm x 152.2mm x 47.4mm (LxHxW) (8.75" x 6.0" x 1.87")
	Material	Main Body: PC-ABS a blend of the two polymers - Polycarbonate (PC) and Acrylonitrile Butadiene Styrene (ABS). Over-moulded Red Rubber, Thermoplastic Elastomer (TPE).
	Operating Temperature	-20 to +60 °C
	Storage Temp	Storage for up to 12 months -20 to +35 °C Nominal +20 °C
	IP Rating	Designed to meet requirements of IP64
Thumbwheel	Number of Detent	12
	Material	Polyamide, polycarbonate.

Conductivity	Frequency/ Resolution	60kHz – 3 decimal points max Auto Resolution Mode AutoS = Legacy Instrument, Auto = SigmaCheck	
	Accuracy	0.5%-10% IACS better than +/-0.05% IACS 10%-25% IACS better than +/-0.25% IACS 25%-60% IACS better than +/-0.5% IACS 60%-110% IACS better than +/-1% IACS	Lift Off corrected to 1.0mm No temperature compensation All Errors at 90% Confidence Level

10 System Self-Test Codes

Error	Name	Description
2	External RAM Initialisation	Configures the internal RAM IO lines.
8	SDRAM Initialisation	If SDRAM config. times out, report ERROR.
32	Memory Tests	Required memory configured and cleared.
512	Accelerometer Initialisation	Configuration over I2C. I2C Comms error returned.
1024	SD Disk Initialisation	If disk not present or failure, error returned.
8192	LCD Screen Buffer test.	Write and read a coloured pixel. Error if different.

11 Safety and Environmental

Safety: Even classified as lithium ion batteries UN3480 or UN3481 (Contained in Equipment or Packed with Equipment), the product is handled as Non-Dangerous Goods by meeting the UN Recommendations on the Transportation of Dangerous Goods Model Regulations Special Provision SP188 and IATA Dangerous Goods Regulations Packing Instruction 965-967 General Requirement and Section II (Excepted) is applied for air transportation, IMDG Code SP188 is applied for marine transportation. Battery has passed the UN T1-T8 tests and may be shipped as excepted from these regulations. Battery MSDS sheet available on request.

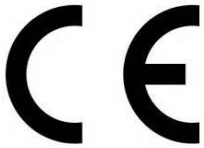

EC Declaration of Conformity - this product is CE marked; CE marking signifies that the product conforms with all EU directives or EU regulations that apply to it.



Environmental Protection: This product should not be disposed of with household waste. Please recycle where facilities exist. Check with your local Authority or retailer for recycling advice.

11.1 EC Declaration of Conformity

We

ETherNDE Ltd

Of

*ETher NDE Ltd.
Endeavour House,
Unit 18, Brick Knoll Park,
Ashley Road,
St Albans,
Hertfordshire,
AL1 5UG
United Kingdom*

Hereby declare that:

Equipment: AeroCheck3 Eddy Current Flaw Detector

Model Number: IAER300, IAER300TW

Meet the intent of Directive 89/336/EEC for Electromagnetic Compatibility.

Compliance tested to:

Test Specification: EN 61326-1:2021
Title: Electrical equipment for measurement, control and laboratory use.

Test Specification: EN 55011:2009 + A1:2010
Title: Industrial, scientific and medical (ISM) radio frequency equipment.
- Radio disturbance characteristics

Test Specification: EN61000 Part 4
Title: Electromagnetic compatibility (EMC)
- Part 4. Testing and measurement techniques.

Sections: EN61000-4-2: 2009 - Electrostatic discharge immunity test.
EN61000-4-3: 2006+A2:2010- Radiated radio frequency electromagnetic field immunity test.